

SONY[®]

4-184-697-12(1)

Multi Channel AV Receiver

Operating Instructions
STR-DA4600ES



* 4 1 8 4 6 9 7 1 2 * (1)

Printed in Malaysia

<http://www.sony.net/>

©2010 Sony Corporation

WARNING

To reduce the risk of fire or electric shock, do not expose this apparatus to rain or moisture.

To reduce the risk of fire, do not cover the ventilation opening of the apparatus with newspapers, tablecloths, curtains, etc. Do not place the naked flame sources such as lighted candles on the apparatus.

Do not install the appliance in a confined space, such as a bookcase or built-in cabinet.

To reduce the risk of fire or electric shock, do not expose this apparatus to dripping or splashing, and do not place objects filled with liquids, such as vases, on the apparatus.

As the main plug is used to disconnect the unit from the mains, connect the unit to an easily accessible AC outlet. Should you notice an abnormality in the unit, disconnect the main plug from the AC outlet immediately.

Do not expose batteries or apparatus with battery-installed to excessive heat such as sunshine, fire or the like.

The unit is not disconnected from the mains as long as it is connected to the AC outlet, even if the unit itself has been turned off.



This symbol is intended to alert the user to the presence of the Hot Surface that may be hot if it is touched during the normal operation.

This equipment has been tested and found to comply with the limits set out in the EMC Directive using a connection cable shorter than 3 meters.

For customers in the United States and Canada



This symbol is intended to alert the user to the presence of uninsulated "dangerous voltage" within the product's enclosure that may be of sufficient magnitude to constitute a risk of electric shock to persons.



This symbol is intended to alert the user to the presence of important operating and maintenance (servicing) instructions in the literature accompanying the appliance.

For customers in the United States

Owner's Record

The model and serial numbers are located on the rear of the unit. Record these numbers in the space provided below. Refer to them whenever you call upon your Sony dealer regarding this product.

Model No. _____ Serial No. _____

Important Safety Instructions

- 1) Read these instructions.
- 2) Keep these instructions.
- 3) Heed all warnings.
- 4) Follow all instructions.
- 5) Do not use this apparatus near water.
- 6) Clean only with dry cloth.
- 7) Do not block any ventilation openings. Install in accordance with the manufacturer's instructions.
- 8) Do not install near any heat sources such as radiators, heat registers, stoves, or other apparatus (including amplifiers) that produce heat.
- 9) Do not defeat the safety purpose of the polarized or grounding-type plug. A polarized plug has two blades with one wider than the other. A grounding type plug has two blades and a third grounding prong. The wide blade or the third prong are provided for your safety. If the provided plug does not fit into your outlet, consult an electrician for replacement of the obsolete outlet.
- 10) Protect the power cord from being walked on or pinched particularly at plugs, convenience receptacles, and the point where they exit from the apparatus.
- 11) Only use attachments/accessories specified by the manufacturer.

12) Use only with the cart, stand, tripod, bracket, or table specified by the manufacturer, or sold with the apparatus. When a cart is used, use caution when moving the cart/apparatus combination to avoid injury from tip-over.



- 13) Unplug this apparatus during lightning storms or when unused for long periods of time.
- 14) Refer all servicing to qualified service personnel. Servicing is required when the apparatus has been damaged in any way, such as power-supply cord or plug is damaged, liquid has been spilled or objects have fallen into the apparatus, the apparatus has been exposed to rain or moisture, does not operate normally, or has been dropped.

To reduce the risk of electric shock, the speaker cord should be connected to the apparatus and the speakers in accordance with the following instructions.

- 1) Disconnect the AC power cord from the MAINS.
- 2) Strip 10 to 15 mm of the wire insulation of the speaker cord.
- 3) Connect the speaker cord to the apparatus and the speakers carefully so as not to touch the core of speaker cord by hand. Also disconnect the AC power cord from the MAINS before disconnecting the speaker cord from the apparatus and the speakers.

The following FCC statement applies only to the version of this model manufactured for sale in the U.S.A. Other versions may not comply with FCC technical regulations.

NOTE:

This equipment has been tested and found to comply with the limits for a Class B digital device, pursuant to Part 15 of the FCC Rules. These limits are designed to provide reasonable protection against harmful interference in a residential installation.

This equipment generates, uses and can radiate radio frequency energy and, if not installed and used in accordance with the instructions, may cause harmful interference to radio communications. However, there is no guarantee that interference will not occur in a particular installation. If this equipment does

cause harmful interference to radio or television reception, which can be determined by turning the equipment off and on, the user is encouraged to try to correct the interference by one or more of the following measures:

- Reorient or relocate the receiving antenna.
- Increase the separation between the equipment and receiver.
- Connect the equipment into an outlet on a circuit different from that to which the receiver is connected.
- Consult the dealer or an experienced radio/TV technician for help.

CAUTION

You are cautioned that any changes or modifications not expressly approved in this manual could void your authority to operate this equipment.

About This Manual

- The instructions in this manual are for model STR-DA4600ES (the receiver). Check your model number by looking at the lower right corner of the front panel.
- The instructions in this manual describe mostly the controls on the supplied simple remote. You can also use the controls on the receiver if they have the same or similar names as those on the remote.

On Copyrights

This receiver incorporates Dolby* Digital and Pro Logic Surround and the DTS** Digital Surround System.

- * Manufactured under license from Dolby Laboratories.
Dolby, Pro Logic, and the double-D symbol are trademarks of Dolby Laboratories.
- ** Manufactured under license under U.S. Patent #'s: 5,451,942; 5,956,674; 5,974,380; 5,978,762; 6,226,616; 6,487,535; 7,212,872; 7,333,929; 7,392,195; 7,272,567 & other U.S. and worldwide patents issued & pending. DTS and the Symbol are registered trademarks, & DTS-HD, DTS-HD Master Audio, and the DTS logos are trademarks of DTS, Inc. Product includes software. © DTS, Inc. All Rights Reserved.

This receiver incorporates High-Definition Multimedia Interface (HDMI™) technology.

HDMI, the HDMI logo and High-Definition Multimedia Interface are trademarks or registered trademarks of HDMI Licensing LLC.

SIRIUS, XM and all related marks and logos are trademarks of Sirius XM Radio Inc. and its subsidiaries. All rights reserved. **Service not available in Alaska and Hawaii.**

The font type (Shin Go R) installed in this receiver is provided by MORISAWA & COMPANY LTD. These names are the trademarks of MORISAWA & COMPANY LTD., and the copyright of the font also belongs to MORISAWA & COMPANY LTD.

iPod is a trademark of Apple Inc., registered in the U.S. and other countries.

All other trademarks and registered trademarks are of their respective holders. In this manual, ™ and ® marks are not specified.

The Bluetooth word mark and logos are owned by the Bluetooth SIG, Inc. and any use of such marks by Sony Corporation is under license. Other trademarks and trade names are those of their respective owners.

DLNA and DLNA CERTIFIED are trademarks and/or service marks of the Digital Living Network Alliance.

Microsoft, Windows, Windows Vista, and Windows Media are trademarks or registered trademarks of Microsoft Corporation in the United States and/or other countries.

Intel, Intel Core, and Pentium are trademarks or registered trademarks of Intel Corporation or its subsidiaries in the United States and other countries.

Rhapsody and the Rhapsody logo are trademarks and/or registered trademarks of RealNetworks, Inc.

SHOUTcast® is a registered trademark of AOL LLC.

THIS PRODUCT IS LICENSED UNDER THE VC-1 PATENT PORTFOLIO LICENSE FOR THE PERSONAL AND NON-COMMERCIAL USE OF A CONSUMER TO

(i) ENCODE VIDEO IN COMPLIANCE WITH THE VC-1 STANDARD (“VC-1 VIDEO”) AND/OR

(ii) DECODE VC-1 VIDEO THAT WAS ENCODED BY A CONSUMER ENGAGED IN A PERSONAL AND NON-COMMERCIAL ACTIVITY AND/OR WAS OBTAINED FROM A VIDEO PROVIDER LICENSED TO PROVIDE VC-1 VIDEO.

NO LICENSE IS GRANTED OR SHALL BE IMPLIED FOR ANY OTHER USE. ADDITIONAL INFORMATION MAY BE OBTAINED FROM MPEG LA, L.L.C. SEE [HTTP://WWW.MPEGLA.COM](http://WWW.MPEGLA.COM)

MPEG Layer-3 audio coding technology and patents licensed from Fraunhofer IIS and Thomson.

“BRAVIA” Sync is a trademark of Sony Corporation.

VAIO is a trademark of Sony Corporation.

“x.v.Color (x.v.Colour)” and “x.v.Color (x.v.Colour)” logo are trademarks of Sony Corporation.

“PlayStation®” is a registered trademark of Sony Computer Entertainment Inc.

Table of Contents

Description and location of parts8

Getting Started

Checking the connection appropriate for your components 19

1: Installing speakers20

2: Connecting the monitor24

3: Connecting the video components25

4: Connecting the audio components34

5: Connecting the IR Blaster38

6: Connecting the antennas (aerials)39

7: Connecting to the network40

8: Preparing the receiver and the remote42

9: Setting the speakers43

10: Calibrating the appropriate speaker settings automatically (Auto Calibration)46

11: Configuring the network settings of the receiver52

12: Preparing a computer to use as a server52

Guide to on-screen display operation54

Playback

Enjoying sound/images from the component connected to the receiver57

Enjoying sound/images from the components connected to the DIGITAL MEDIA PORT58

Operating the TDM-iP50 using the GUI menu of the receiver59

Tuning

Listening to FM/AM radio62

Presetting FM/AM radio stations64

Listening to satellite radio65

Connecting a satellite radio tuner65

Preparing to listen to a satellite radio66

Selecting a channel of the satellite radio66

Presetting satellite radio channels 68

Restricting access to specific channels (Parental Lock) 68

Enjoying Surround Sound

Playing back with 2-channel sound 72

Playing back with multi-channel surround 73

Enjoying a surround effect for music 74

Enjoying a surround effect for movies 76

Using Network Features

About the network functions of the receiver 79

Enjoying content stored on the server 80

Using a controller 83

Listening to Rhapsody 84

Listening to SHOUTcast 87

Features of the Setup Manager application software 88

Using Multi-zone Features

What you can do with the Multi-zone function 90

Making a multi-zone connection 90

Setting the speakers in zone 2 94

Switching the zone setting of the remote ... 95

Operating the receiver from another zone (ZONE 2/ZONE 3 operations) 95

Using Other Features

Using “BRAVIA” Sync features 97

Switching the monitors that output the HDMI video signals 99

Outputting the HDMI signals even when the receiver is in standby mode (Pass Through) 100

Switching between digital and analog audio	101
Enjoying the sound/images from other inputs (Input Assign)	102
Using the sleep timer	104
Enjoying the surround effect at low volume levels (Night Mode)	104
Recording using the receiver	105
Switching the command mode of the receiver and the remote	106
Using a bi-amplifier connection	107

Adjusting Settings

Using the setting menu	109
Auto Calibration	110
Speaker settings	112
Surround settings	116
EQ settings	117
Multi Zone settings	117
Audio settings	119
Video settings	121
HDMI settings	123
Network settings	124
Quick Click settings	127
System settings	127
Operating without connecting to a TV	129

Operating Each Component Using the On-screen Remote (Quick Click)

Operating components or lighting connected to the receiver using the on-screen remote (Quick Click)	136
Using Quick Click	137
Setting components that are operated by the on-screen remote	142
Performing several commands in sequence automatically with Quick Click (Macro Play)	142
Setting remote control codes that are not stored in Quick Click	144
Resetting the remote code for Quick Click	145

Operating Each Component Using the Multifunction Remote

Operating each component using the multifunction remote	146
Programming the remote	147
Performing several commands in sequence automatically (Macro Play)	151
Setting remote commander codes that are not stored in the remote	152
Clearing all the contents of the remote's memory	154

Additional Information

Precautions	155
Troubleshooting	156
Specifications	163
Index	167

Description and location of parts

Front panel

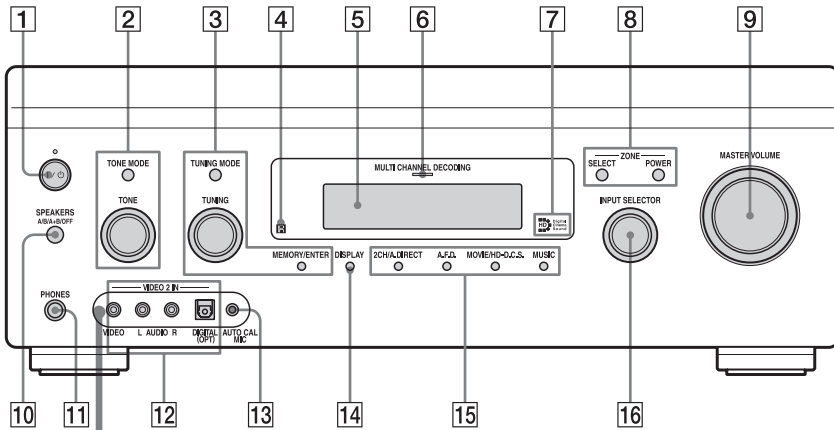

To remove the cover

Press PUSH.

When you remove the cover, keep it out of reach from children.

1 I/O (on/standby)

Press to turn the receiver on or off. When the power is on, the lamp above the button lights up in green.

Saving the power in standby mode.

When “Control for HDMI” (page 123), “Network Standby” (page 126), and “RS232C Control” (page 127) are set to “OFF,” and the power for zone 2/zone 3 is turned off.

If “Control for HDMI” or “Network Standby” is set to “ON,” “A.STNDBY” appears in the display window of the receiver while the receiver is in standby mode.

2 TONE MODE, TONE

Adjusts FRONT, CENTER, SURROUND/SURROUND BACK, FRONT HIGH BASS and TREBLE. Press TONE MODE repeatedly to select BASS or TREBLE, then turn TONE to adjust the level.

3 TUNING MODE, TUNING, MEMORY/ENTER

Press to operate a tuner (FM/AM) and satellite radio (SIRIUS).

4 Remote sensor

Receives signals from remote commander.

5 Display window (page 10)

6 MULTI CHANNEL DECODING lamp

Lights up when multi-channel audio signals are decoded.

- 7 HD Digital Cinema Sound lamp (page 76)**
Lights up when a sound field with HD-D.C.S. is selected.
- 8 ZONE/SELECT, POWER (page 90)**
Press SELECT repeatedly to select zone 2, zone 3 or main zone. Each time you press POWER, the output signals for the selected zone will be turned on or off.
- 9 MASTER VOLUME**
Turn to adjust the volume level of all speakers at the same time.
- 10 SPEAKERS (A/B/A+B/OFF) (page 45)**
- 11 PHONES jack**
Connects to headphones.
- 12 VIDEO 2 IN jacks (page 32)**
- 13 AUTO CAL MIC jack (page 46)**
- 14 DISPLAY**
Press repeatedly to select information displayed on the display.
- 15 2CH/A.DIRECT, A.F.D., MOVIE/ HD-D.C.S., MUSIC (page 72, 73, 74, 76)**
- 16 INPUT SELECTOR**
Turn to select the input source to play back.
To select the input source for zone 2 or zone 3, press ZONE SELECT (**8**) to select zone 2 or zone 3 first (“2.input name” or “3.input name” appears on the display), then turn INPUT SELECTOR to select the input source.

Indicators on the display

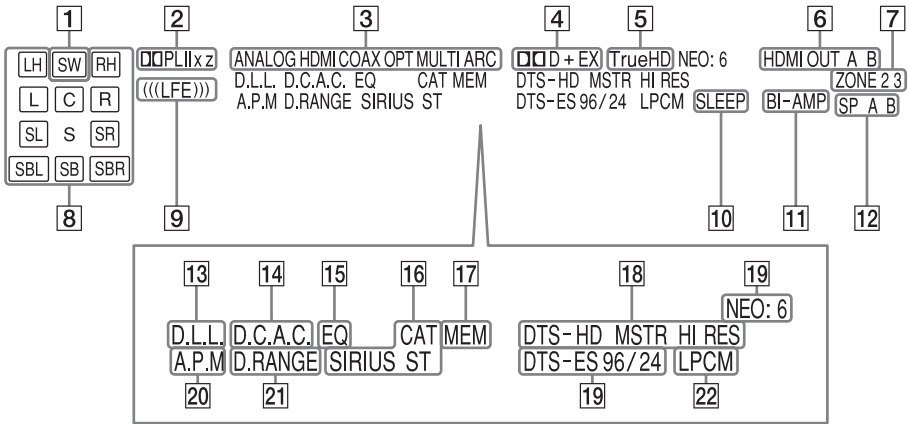

1 SW

Lights up when subwoofer is connected and the audio signal is output from the SUBWOOFER jack.

2 Dolby Pro Logic indicators

Lights up one of the respective indicators when the receiver performs Dolby Pro Logic processing. This matrix surround decoding technology can enhance input signals.

DDPL

Dolby Pro Logic

DDPLII

Dolby Pro Logic II

DDPLIIx

Dolby Pro Logic IIx

DDPLIIz

Dolby Pro Logic IIz

Note

This indicator does not light when either the center speaker and surround speaker is not connected.

3 Input indicators

Light up to indicate the current input.

ANALOG

No digital signal is being input. When INPUT MODE is set to “Analog;” or when the “2ch Analog Direct” is being selected, it also lights up.

HDMI

The receiver recognizes a component connected via an HDMI IN jack.

COAX

Digital signal is input through the COAXIAL jack.

OPT

Digital signal is input through the OPTICAL jack.

MULTI

The multi-channel input is selected.

ARC (page 101)

TV input is selected and the Audio Return Channel (ARC) signals are detected.

4 Dolby Digital Surround indicators

Lights up one of the respective indicators when the receiver is decoding the corresponding Dolby Digital format signals.

DDD

Dolby Digital

Dolby+

Dolby Digital Plus

Dolby EX

Dolby Digital Surround EX

Note

When playing a Dolby Digital format disc, be sure that you have made digital connections and that INPUT MODE is not set to "Analog."

5 TrueHD

Lights up when the receiver is decoding Dolby TrueHD.

6 HDMI OUT A B (page 99)

Lights up when the signals are output from the HDMI OUT A or B jack.

7 ZONE 2 3

Lights up while operation in zone 2/zone 3 is being enabled.

8 Playback channel indicators

The letters (L, C, R, etc.) indicate the channels being played back. The boxes around the letters vary to show how the receiver downmixes the source sound (based on the speaker settings).

L

Front Left

R

Front Right

C

Center (monaural)

LH

Left High

RH

Right High

SL

Surround Left

SR

Surround Right

S

Surround (monaural or the surround components obtained by Pro Logic processing)

SBL

Surround Back Left

SBR

Surround Back Right

SB

Surround Back (the surround back components obtained by 6.1 channel decoding)

Example:

Recording format (Front/Surround): 3/2.1

Output channel: Surround speakers are set to "NO."

Sound Field: A.F.D. Auto

**9 LFE**

Lights up when the disc being played back contains an L.F.E. (Low Frequency Effects) channel.

10 SLEEP

Lights up when the sleep timer is activated.

11 BI-AMP

Lights up when surround back speakers selection is set to "BI-AMP."

12 SP AB (page 45)**13 D.L.L.**

Lights up when the D.L.L. (Digital Legato Linear) function is activated.

14 D.C.A.C.

Lights up when auto calibration is performed.

15 EQ

Lights up when the equalizer is activated.

16 Tuning indicators

Lights up when the receiver tunes in radio stations, or satellite radio stations.

CAT

The category mode is selected during the satellite radio operation.

SIRIUS

The SiriusConnect Home tuner is connected and "SIRIUS" is selected.

ST

Stereo broadcast

17 MEM

A memory function, such as Name Input, etc., is activated.

18 DTS-HD indicators

Light up when the receiver is decoding DTS-HD.

DTS-HD

Lights up constantly with the one of the following indicators.

MSTR

DTS-HD Master Audio

HI RES

DTS-HD High Resolution Audio

19 DTS(-ES) indicators

Light up when DTS or DTS-ES signals are input.

DTS

Lights up when the receiver is decoding DTS signals. Either 96/24 or NEO:6 also lights up depending on the input signal format or decoding format.

DTS-ES

Lights up with the either following indicator depending on the input signal decoding format.

96/24

DTS 96/24 (96 kHz/24 bit) decoding

NEO:6

DTS Neo:6 Cinema/Music

Note

When playing a DTS format disc, be sure that you have made digital connections and that INPUT MODE is not set to "Analog."

20 A.P.M (page 110)

Lights up when the A.P.M. (Automatic Phase Matching) function is activated.

21 D.RANGE

Lights up when dynamic range compression is activated.

22 LPCM

Lights up when Linear PCM (Pulse Code Modulation) signals are input.

Rear panel

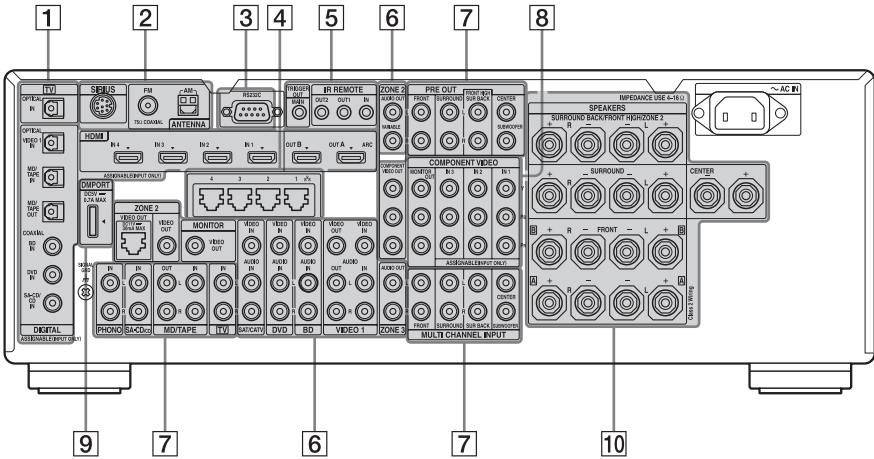

1 DIGITAL INPUT/OUTPUT section
(page 24, 28, 34)



OPTICAL IN/OUT jacks



COAXIAL IN jacks



HDMI IN/OUT* jacks
(page 24, 25)

2 ANTENNA section



FM ANTENNA jack
(page 39)



AM ANTENNA jack
(page 39)



SIRIUS jack (page 65)

3 RS232C port

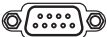

Used for maintenance and service.

4 LAN ports (switching hubs)
(page 41)



5 Control jacks for Sony equipment
and other external components



IR REMOTE IN/OUT jacks
(page 38, 90)



TRIGGER OUT jacks
(page 118)

Connect to interlock on/off of the power supply of other 12V TRIGGER compliant components.

6 VIDEO/AUDIO INPUT/OUTPUT section (page 24, 28, 31)

L  **AUDIO IN/OUT jacks**

R 

 **VIDEO IN/OUT* jacks**

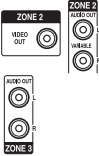

AUDIO OUT jacks
VIDEO OUT jack
(page 90)



ZONE 2 VIDEO OUT jack
(page 92)

An RJ-45 jack used to send a video signal to the component in zone 2. Use a CAT5 cable for the connection. Used for custom installation. For information on how to use this jack, consult your dealer.

Attention

Do not use this jack for an Ethernet LAN connection. Doing so may cause a malfunction.

7 AUDIO INPUT/OUTPUT section

L  **AUDIO IN/OUT jacks**

R  **(page 37)**



MULTI CHANNEL INPUT jacks (page 36)

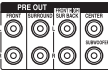

PRE OUT jacks

Connect to an external power amplifier.

8 COMPONENT VIDEO INPUT/OUTPUT section (page 24, 28)

 Y

 Pb **Y, Pb, Pr IN/OUT* jacks**

 Pr

9 DMPORT (page 34)



10 SPEAKERS section (page 22)



* You can watch the selected input image when you connect the HDMI OUT or MONITOR OUT jacks to a TV (page 24).

Remote commander

You can use the supplied remote to operate the receiver and to control the Sony audio/video components that the remote is assigned to operate.

Simple remote commander (RM-AAU061)

This remote can only be used to operate the receiver. You can control the main functions of the receiver with simple operations using this remote.

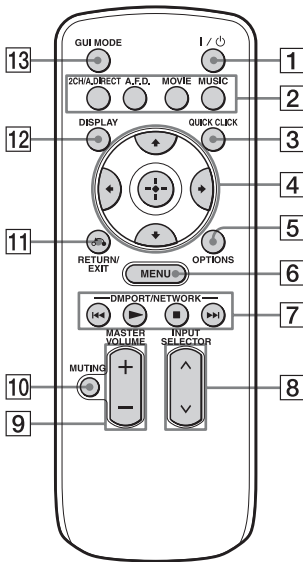

- 7 **DMPORT/NETWORK, ►, ■, ◀◀/▶▶** (page 58, 81)
- 8 **INPUT SELECTOR**
Press to select the input source to play back.
- 9 **MASTER VOLUME +/-** (page 57)
- 10 **MUTING** (page 57)
- 11 **RETURN/EXIT ↶ ↷** (page 54)
- 12 **DISPLAY**
Press repeatedly to select information displayed on the display.
- 13 **GUI MODE** (page 54)

- 1 **I/⏻ (on/standby)**
Press to turn a receiver on or off.
- 2 **2CH/A.DIRECT, A.F.D., MOVIE, MUSIC** (page 72, 73, 74, 76)
- 3 **QUICK CLICK** (page 137)
- 4 **⊕ ⬆/⬇/⬅/➡**
Press **⬆/⬇/⬅/➡** to select the menu item.
Then press **⊕** to enter the selection.
- 5 **OPTIONS** (page 55)
- 6 **MENU** (page 43, 54)

Multifunction remote commander (RM-AAL034)

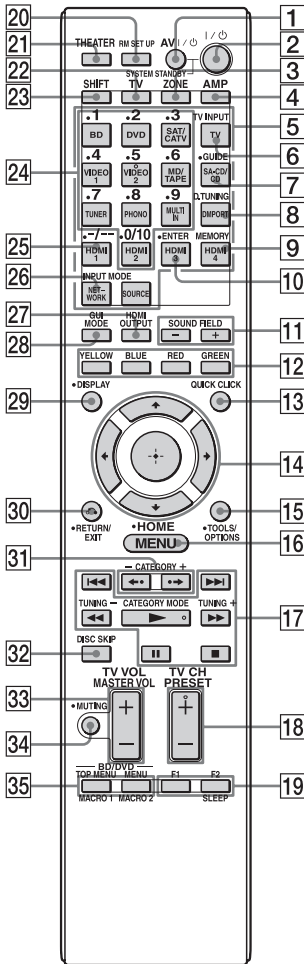

1 AV I/O (on/standby)

Press to turn on or off the audio/video components that the remote is assigned to operate (page 147).
If you press I/O (2) at the same time, it will turn off the receiver and all other components including an amplifier in zone 2 or zone 3 (SYSTEM STANDBY).

Note

The function of the AV I/O switch changes automatically each time you press the input button (5).

2 I/O (on/standby)

Press to turn the receiver on or off.
If you press ZONE (3) to switch the remote to zone 2 (zone 3) mode, you can turn the power for zone 2 (zone 3) on or off using I/O.

3 ZONE (page 90)

4 AMP

Press to enable the receiver operation for main zone.

5 Input buttons

Press one of the buttons to select the component you want to use. When you press any of the input buttons, the receiver turns on. The buttons are factory assigned to control Sony components (page 57). You can program the remote to control non-Sony components following the steps in "Programming the remote" (page 147).

6 TV INPUT

Press TV (22), then press TV INPUT to select the input signal of a TV.

7 GUIDE

Press SHIFT (23), then press GUIDE to display the on-screen program guide.

8 D.TUNING (page 62, 67)

Press SHIFT (23), then press to enter direct tuning mode.

9 MEMORY

Press SHIFT (23), then press MEMORY to enter the Memory mode of the tuner.

10 ENTER

Press SHIFT (23), then press ENTER to enter the value after selecting a channel, disc, or track using the numeric buttons, or to store a station during tuner operation.





11 SOUND FIELD +/- (page 72, 73, 74, 76)

Select a sound field.

12 Color buttons

Display an operation guide on the TV screen when the color buttons are available. Follow the operation guide to perform a selected operation.

13 QUICK CLICK (page 137)**14** 

Press /// to select the menu items. Then press  to enter the selection.

15 TOOLS/OPTIONS

Press to display and select items from option menus for receiver, DVD player, TV, or Blu-ray Disc Player, etc.

16 MENU, HOME

Press to display the menu used to operate audio/video components or a TV.

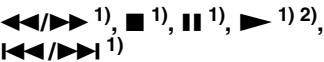
17 

Press to operate the DVD player, Blu-ray Disc Player, CD player, MD deck, tape deck, or component connected to the DIGITAL MEDIA PORT adapter etc.

CATEGORY MODE

Press to select the category mode for satellite tuner.

TUNING +/-

Press to select station.

18 PRESET + 2)/-

Press to select preset stations.

TV CH + 2)/-

Press TV () , then press TV CH +/- to operate the TV, satellite tuner, VCR, etc.

19 F1/F2

Press BD or DVD () , then press F1 or F2 to select a component to operate.
HDD/DISC combo

F1: HDD

F2: DVD disc, Blu-ray Disc
DVD/VCR combo

F1: DVD disc, Blu-ray Disc

F2: VCR

SLEEP (page 104)

Press AMP () , then press SLEEP to activate the sleep timer function.

20 RM SET UP (page 106)**21 THEATER**

Press to turn the Theater Mode on and off when connecting the receiver to products featuring “BRAVIA” Sync.

22 TV



Press to enable the TV operation.

23 SHIFT

Press to light up the button. It changes the remote button function to activate the buttons with pink printing.

24 Numeric buttons

Press SHIFT () , then press to

- preset/tune to preset stations.
- select track numbers of the CD player, DVD player, Blu-ray Disc Player or MD deck. Press -/-- () to select track number 10.
- select channel numbers of the VCR or satellite tuner.
- After pressing TV () , press the numeric buttons to select the TV channels.

25 -/--

Press to

- select track numbers over 10 of the CD player, DVD player, Blu-ray Disc Player, or MD deck.
- select channel numbers over 10 of the TV, Satellite tuner or the VCR.

26 INPUT MODE (page 102)

Press SHIFT () , then press to select the input mode when the same components are connected to both digital and analog jacks.

27 HDMI OUTPUT (page 99)**28 GUI MODE (page 54)****29 DISPLAY**

Press repeatedly to select information displayed on the display.

30 RETURN/EXIT 

Press to return to the previous menu or exit the menu while the menu or on-screen guide of the Blu-ray Disc Player,

DVD player, or satellite tuner is displayed on the TV screen.

31 CATEGORY +/-

Press to select the category for satellite tuner.



Press to select an album.

32 DISC SKIP

Press to skip a disc when using a multi-disc changer.

33 MASTER VOL +/-

Press to adjust the volume level of all speakers at the same time.

TV VOL +/-

Press TV (**22**), then press TV VOL +/- to adjust the volume level of the TV.

34 MUTING

Press to turn off the sound temporarily. Press the button again to restore the sound.

35 BD/DVD/TOP MENU, MENU

Press to display the menus of the DVD player on the TV screen. Then use **▲/▼/◀/▶** and **⊕** to perform a menu operations.

MACRO1, MACRO2 (page 151)

Press AMP (**4**), then press MACRO 1 or MACRO 2 to set up the macro function.

¹See the table on page 146 for information on the buttons that you can use to control each component.

²The tactile dot is attached to these buttons (VIDEO 2/5, **▶**, PRESET +/TV CH +). Use as a mark of operation.

Notes

- Some functions explained in this section may not work depending on the model.
- The above explanation is intended to serve as an example only. Therefore, depending on the component, the above operation may not be possible or may operate differently than described.

Checking the connection appropriate for your components

Installing Speakers

See "1: Installing speakers" (page 20).



Connecting the monitor and video components

The image quality depends on the connecting jack. See the illustration on the right. Select the connection according to the jacks on your components.

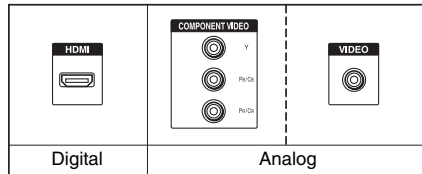

Q: Does your monitor have an HDMI jack?

- **No:** See the connection for a TV monitor without an HDMI jack in "2: Connecting the monitor" (page 24) and "Connecting components without HDMI jacks" (page 28).
- **Yes:** See the connection for the TV monitor with HDMI jack in "2: Connecting the monitor" (page 24).

↳ Q: Does your video component have an HDMI jack?

- **No:** See "Connecting components without HDMI jacks" (page 28).
- **Yes:** See "Connecting components with HDMI jacks" (page 25).



Connecting the audio components

See "4: Connecting the audio components" (page 34).



Setting the audio output settings on the connected components

To output multi-channel digital audio, check the digital audio output setting on the connected components.
 For a Blu-ray Disc Player, check that "Audio (HDMI)," "Dolby Digital (Coaxial/Optical)," and "DTS (Coaxial/Optical)" are set to "Auto," "Dolby Digital," and "DTS," respectively (as of March 2010).
 For a PlayStation 3, check that "BD Audio Output Format" is set to "Bitstream" (with system software version 3.15).
 For details, refer to the operating instructions supplied with the connected components.



Preparing the receiver and the remote

See "8: Preparing the receiver and the remote" (page 42).



Setting the speakers

Select the speaker pattern, then perform auto calibration. For details, see "9: Setting the speakers" (page 43) and "10: Calibrating the appropriate speaker settings automatically (Auto Calibration)" (page 46).

Note

You can check the speaker connection using "Test Tone" (page 114). If the sound is not output correctly, check the speaker connection and make the settings explained above, again.

1: Installing speakers

This receiver allows you to use a 7.1 channel system (7 speakers and one subwoofer).

Examples of speaker system configuration

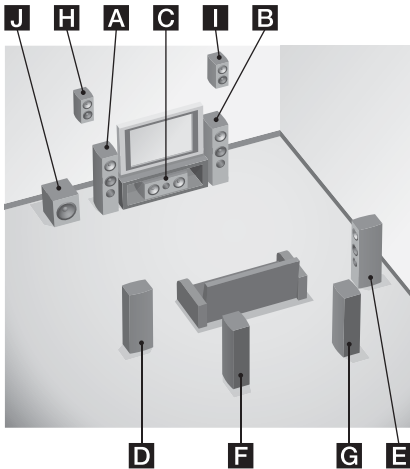

5.1 channel speaker system

To fully enjoy theater-like multi-channel surround sound requires five speakers (two front speakers, a center speaker, and two surround speakers) and a subwoofer (5.1 channel system).

- A** Front left speaker
- B** Front right speaker
- C** Center speaker
- D** Surround left speaker
- E** Surround right speaker
- J** Subwoofer

7.1 channel speaker system using surround back speakers

You can enjoy high fidelity reproduction of DVD or Blu-ray Disc software recorded sound in 6.1 channel or 7.1 channel format if you connect one additional surround back speaker (6.1 channel system) or two surround back speakers (7.1 channel system).

- A** Front left speaker
- B** Front right speaker
- C** Center speaker
- D** Surround left speaker
- E** Surround right speaker
- F** Surround back left speaker
- G** Surround back right speaker
- J** Subwoofer

7.1 channel speaker system using front high speakers

You can enjoy vertical sound effects (e.g., Pro Logic IIz mode) if you connect additional two front high speakers.

- A** Front left speaker
- B** Front right speaker
- C** Center speaker
- D** Surround left speaker
- E** Surround right speaker
- H** Left high speaker
- I** Right high speaker
- J** Subwoofer

Tips

- The angle **A** should be the same.

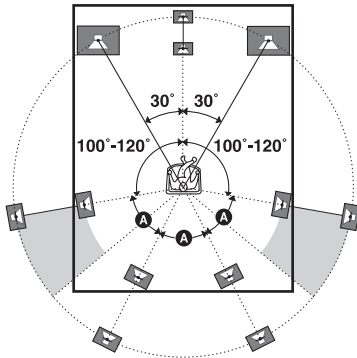

- When you connect a 6.1 channel speaker system, place the surround back speaker behind the seating position.

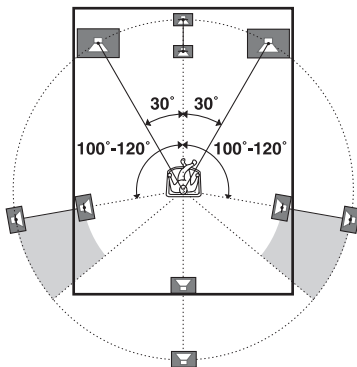

- Since the subwoofer does not emit highly directional signals, you can place it wherever you want.

Connecting speakers

Before connecting cords, make sure to disconnect the AC power cord (mains lead).

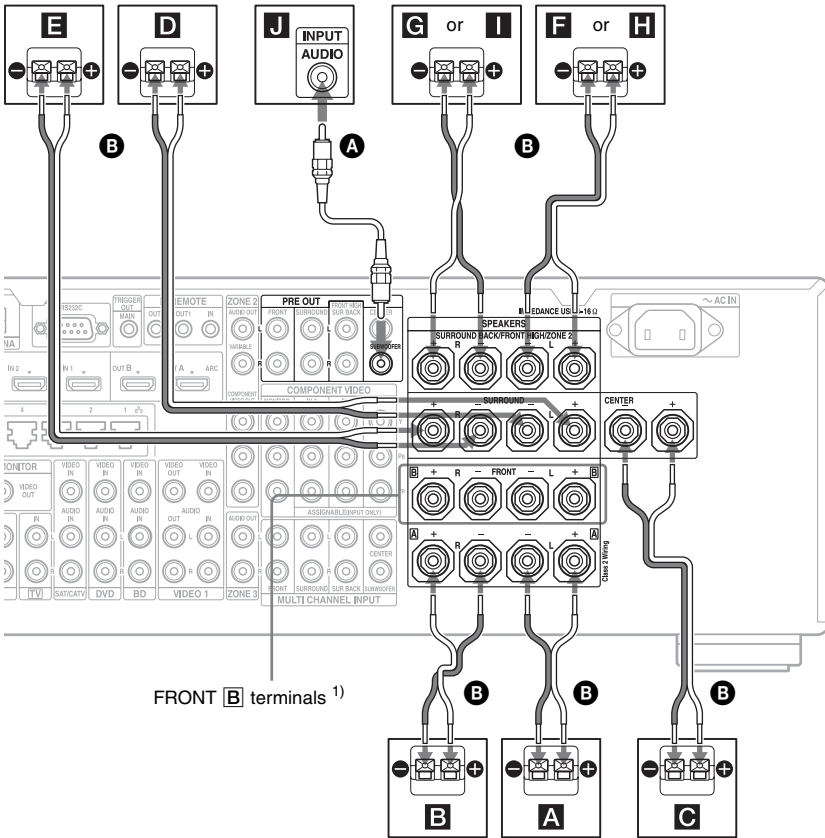

FRONT **B** terminals ¹⁾

- A** Monaural audio cord (not supplied)
- B** Speaker cords (not supplied)
- A** Front speaker **A** (L)
- B** Front speaker **A** (R)
- C** Center speaker
- D** Surround speaker (L)
- E** Surround speaker (R)
- F** Surround back speaker (L)²⁾
- G** Surround back speaker (R)²⁾
- H** Front high speaker (L)
- I** Front high speaker (R)
- J** Subwoofer³⁾

- ¹⁾ If you have an additional front speaker system, connect them to the FRONT **B** terminals. You can select the front speaker system you want to use with SPEAKERS on the front panel (page 45).
- ²⁾ If you connect only one surround back speaker, connect it to the SURROUND BACK/FRONT HIGH/ZONE 2 L terminals.
- ³⁾ When you connect a subwoofer with an auto standby function, turn off the function when watching movies. If the auto standby function of the subwoofer is set to on, it goes into standby automatically based on the level of the input signal to a subwoofer, then sound may not be output.

Notes

- When you connect all the speakers with a nominal impedance of 8 ohms or higher, set “Impedance” in the Speaker settings menu to “8 ohms.” In other connections, set it to “4 ohms.” For details, see “9: Setting the speakers” (page 43).
- Before connecting the AC power cord (mains lead), make sure that metallic wires of the speaker cords are not touching each other between the SPEAKERS terminals.

Tips

- You can loosen or tighten the SPEAKERS terminal easily using the supplied speaker cord connection tool.

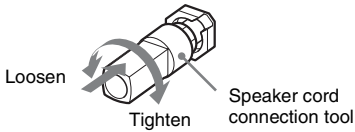

- To connect certain speakers to another power amplifier, use the PRE OUT jacks. The same signal is output from both the SPEAKERS terminals and the PRE OUT jacks. For example, if you want to connect just the front speakers to another amplifier, connect that amplifier to the PRE OUT FRONT L and R jacks.

ZONE 2 connection

You can assign the SURROUND BACK/FRONT HIGH/ZONE 2 terminals **F** and **G** to the speakers of the zone 2. Set “Sur Back Assign” to “ZONE2” in the Speaker settings menu.

See “Using Multi-zone Features” (page 90) for details on connection and operation in zone 2.

Note

If the speaker pattern is set so that there are surround back speakers or front high speakers, you cannot use the speakers of the zone 2 as intended.

2: Connecting the monitor

You can watch the selected input image when you connect the HDMI OUT or MONITOR OUT jacks to a TV. You can operate this receiver using a GUI (Graphical User Interface).

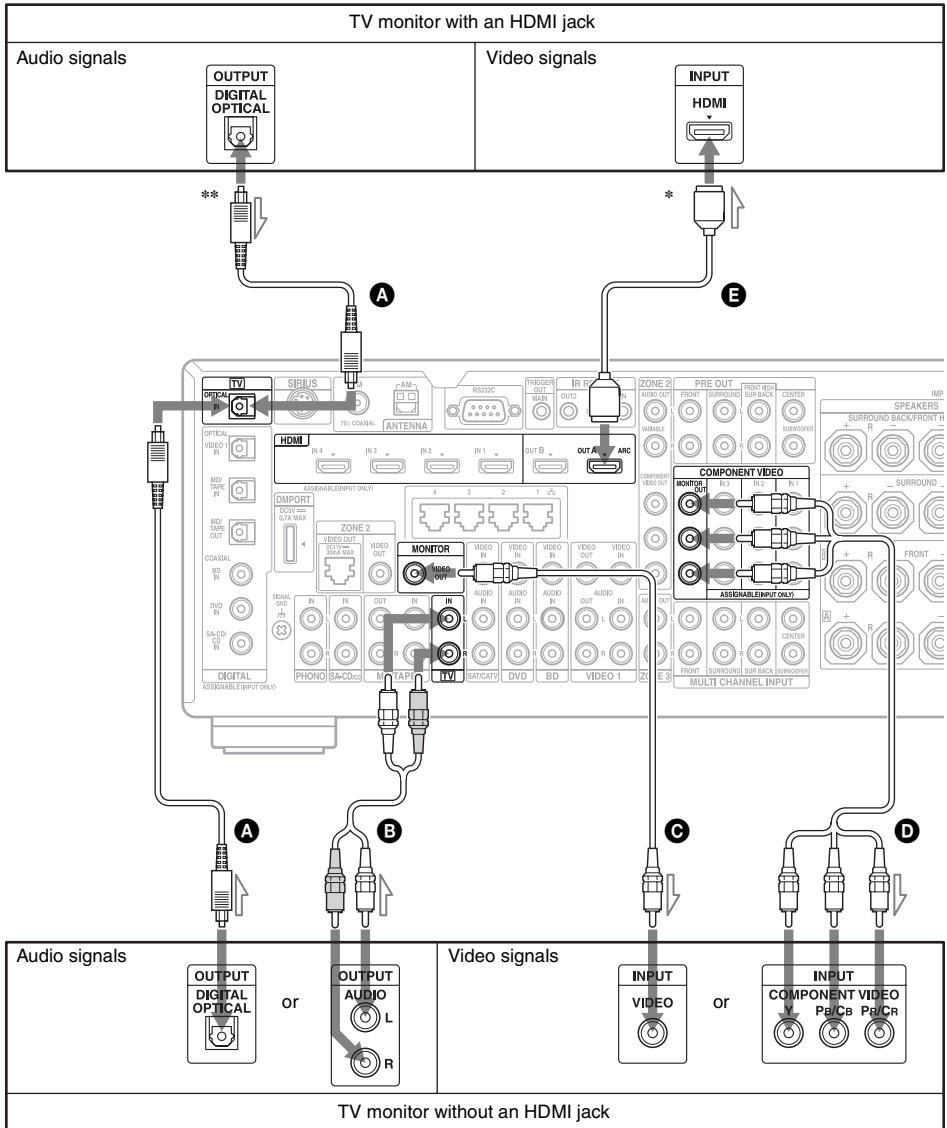

- A** Optical digital cord (not supplied)
- B** Audio cord (not supplied)
- C** Video cord (not supplied)

- D** Component video cord (not supplied)
 - E** HDMI cable (not supplied)
- We recommend that you use a Sony HDMI cable.

- * If your TV is compatible with the Audio Return Channel (ARC) function, the TV sound will output from the speakers connected to the receiver via the HDMI OUT A jack. In this case, set “Control for HDMI” to “ON” in HDMI settings menu (page 123). If you want to select an audio signal using other than an HDMI cable (e.g., via an optical digital cord or an audio cord), switch the audio input mode using INPUT MODE (page 101).
- ** If you connect the receiver to the ARC compatible TV’s HDMI jack via an HDMI cable, you do not need to connect the TV to the receiver with the digital optical cord.

To enjoy TV multi channel surround sound broadcasting

You can listen to TV multi channel surround sound broadcasting from the speakers connected to the receiver.

Connect the OPTICAL output jack of the TV to the OPTICAL IN jack of the receiver, or connect the HDMI input jack of the TV compatible with the Audio Return Channel (ARC) function to the HDMI OUT A jack of the receiver.

Notes

- Before connecting cords, make sure to disconnect the AC power cord (mains lead).
- Connect image display components such as a TV monitor or a projector to the MONITOR VIDEO OUT jack on the receiver. You may not be able to record, even if you connect recording components.
- Turn on the receiver when the video and audio of a playback component are being output to a TV via the receiver. If the power supply of the receiver is not turned on, neither video nor audio is transmitted.
- Depending on the status of the connection between the TV and the antenna (aerial), the image on the TV screen may be distorted. In this case, place the antenna (aerial) farther away from the receiver.

Tips

- The receiver has a video conversion function. For details, see “Notes on converting video signals” (page 33).
- The sound of the TV is output from the speakers connected to the receiver if you connect the audio output jack of the TV and the TV IN jacks of the receiver. In this configuration, set the sound output

jack of the TV to “Fixed” if it can be switched between either “Fixed” or “Variable.”

3: Connecting the video components

Connecting components with HDMI jacks

HDMI is the abbreviated name for High-Definition Multimedia Interface. It is an interface which transmits video and audio signals in digital format.

HDMI features

- A digital audio signals transmitted by HDMI can be output from the speakers and the PRE OUT jacks on this receiver. This signal supports Dolby Digital, DTS, and Linear PCM. For details, see “Digital audio formats supported by the receiver” (page 78).
- Analog video signals input to the VIDEO jack, or COMPONENT VIDEO jacks can be output as HDMI signals. Audio signals are not output from the HDMI OUT jacks when the image is converted.
- This receiver supports High Bitrate Audio (DTS-HD Master Audio, Dolby TrueHD), Deep Color (Deep Colour), x.v.Color (x.v.Colour) and 3D transmission.
- The HDMI jacks of this receiver support the Control for HDMI function. The HDMI OUT B jack, however, does not support the Control for HDMI function.

DVD player, Blu-ray Disc Player, PlayStation 3, Hard disk recorder, Satellite tuner/Cable box, Camcorder, etc.

Audio/video signals

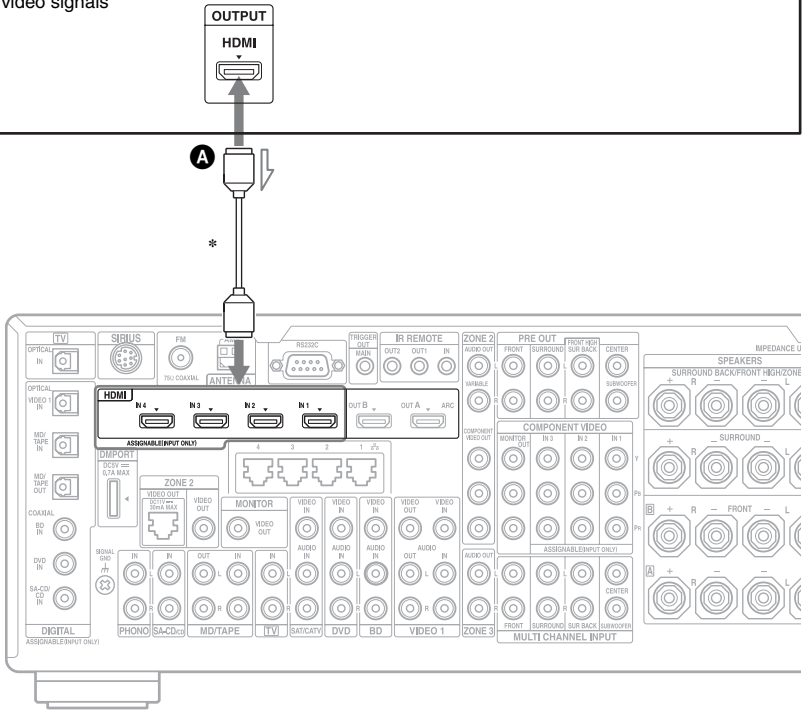

A HDMI cable (not supplied)

We recommend that you use a Sony HDMI cable.

* You can connect any components with HDMI output jacks to the HDMI IN jacks of the receiver. However, HDMI IN 4 is an input which takes sound quality into account.

Notes on connecting cables

- Use a High Speed HDMI cable. If you use a Standard HDMI cable, 1080p, Deep Color, or 3D images may not be displayed properly.
- Sony recommends that you use an HDMI-authorized cable or Sony HDMI cable.
- We do not recommend using an HDMI-DVI conversion cable. When you connect an HDMI-DVI conversion cable to a DVI-D component, the sound and/or the image may not be output. Connect other audio cords or

digital connecting cords, then set “Input Assign” in the Input Option menu when the sound is not output correctly.

- Before connecting cables, make sure to disconnect the AC power cord (mains lead).

Notes on HDMI connections

- An audio signal input to the HDMI IN jack is output from the speaker output jacks, PHONES jack, HDMI OUT jack and PRE OUT jacks. It is not output from any other audio jacks.
- A video signal input to the HDMI IN jack can only be output from the HDMI OUT jack. The video input cannot be output from the VIDEO OUT jacks or MONITOR VIDEO OUT jacks.
- When you want to listen to the sound from the TV speaker, set “Audio Out” to

“TV+AMP” in the HDMI settings menu. If set to “AMP,” the sound is not output from the TV speaker. If you output the multi-channel sound from the receiver, set to “AMP.”

- Be sure to turn on the receiver when video and audio signals of a playback component are being output to a TV through this receiver. If you set “Pass Through” to “OFF,” unless the power is on, neither video nor audio signals will be transmitted.
- Audio signals (format, sampling frequency, bit length, etc.) transmitted from an HDMI jack may be suppressed by the connected component. Check the setup of the connected component if an image is poor or the sound does not come out of a component connected via the HDMI cable.
- Sound may be interrupted when the sampling frequency, the number of channels or audio format of audio output signals from the playback component is switched.
- When the connected component is not compatible with copyright protection technology (HDCP), the image and/or the sound from the HDMI OUT jack may be distorted or may not be output. In this case, check the specification of the connected component.
- Set the image resolution of the player to more than 720p/1080i to enjoy High Bitrate Audio (DTS-HD Master Audio, Dolby TrueHD).
- The image resolution of player may need certain settings be made before you can enjoy multi-channel Linear PCM. Refer to the operating instructions of the player.
- You can enjoy High Bitrate Audio (DTS-HD Master Audio, Dolby TrueHD), and multi-channel Linear PCM with an HDMI connection only.
- To enjoy 3D images, connect 3D-compatible TV and video components (Blu-ray Disc Player, Blu-ray Disc recorder, PlayStation 3, etc.) to the receiver using High Speed HDMI cables, put on 3D glasses, and then play back a 3D-compatible content.

- Not every HDMI component supports all functions that are defined by the specified HDMI version. For example, components that support HDMI, ver. 1.3a, may not support Deep Color.
- Refer to the operating instructions of each component connected for details.

Connecting components without HDMI jacks

To connect a DVD player, Blu-ray Disc Player

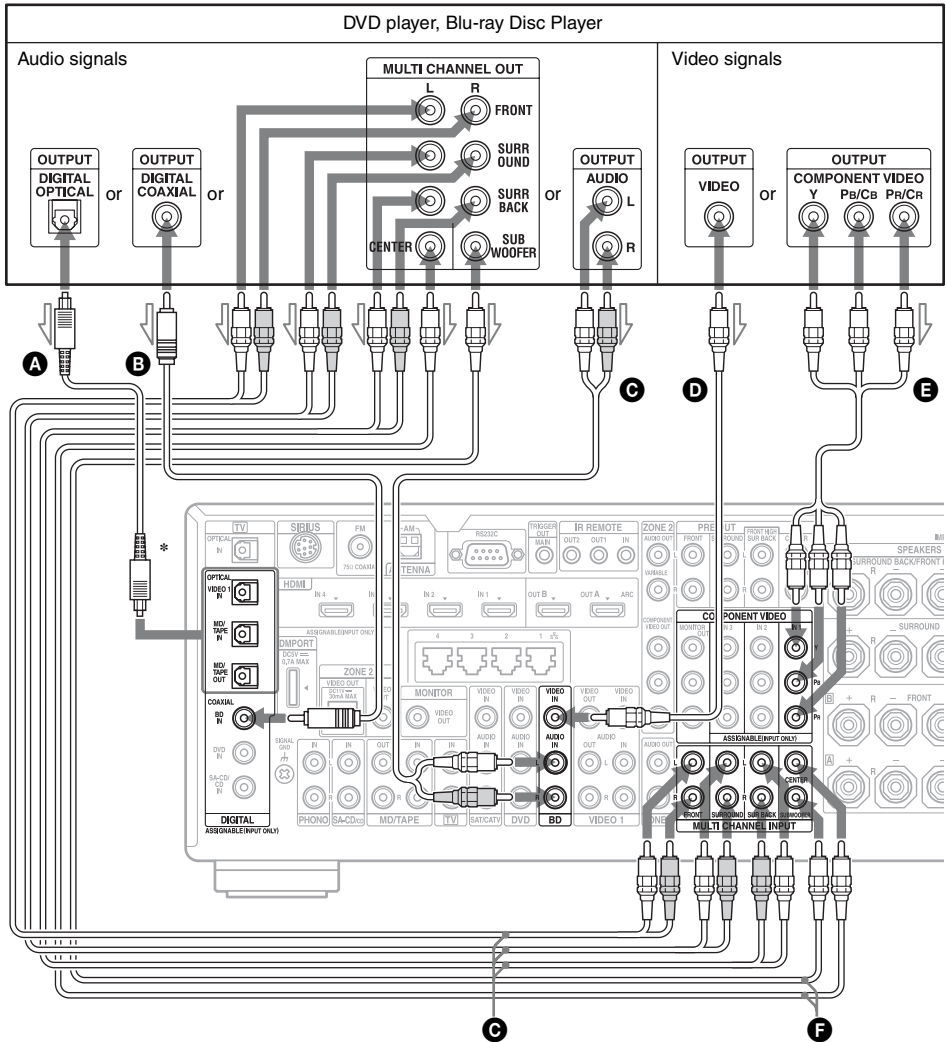

- A** Optical digital cord (not supplied)
- B** Coaxial digital cord (not supplied)
- C** Audio cord (not supplied)
- D** Video cord (not supplied)
- E** Component video cord (not supplied)
- F** Monaural audio cord (not supplied)

* When you connect a component equipped with an OPTICAL jack, set "Input Assign" in the Input menu (page 102).

Notes

- To output multi-channel digital audio, set the digital audio output setting on the DVD player, Blu-ray Disc Player. Refer to the operating instructions supplied with the DVD player, Blu-ray Disc Player.
- DVD player and Blu-ray Disc Player may not have the SURROUND BACK jacks.
- Before connecting cords, make sure to disconnect the AC power cord (mains lead).

To connect a satellite tuner, cable box

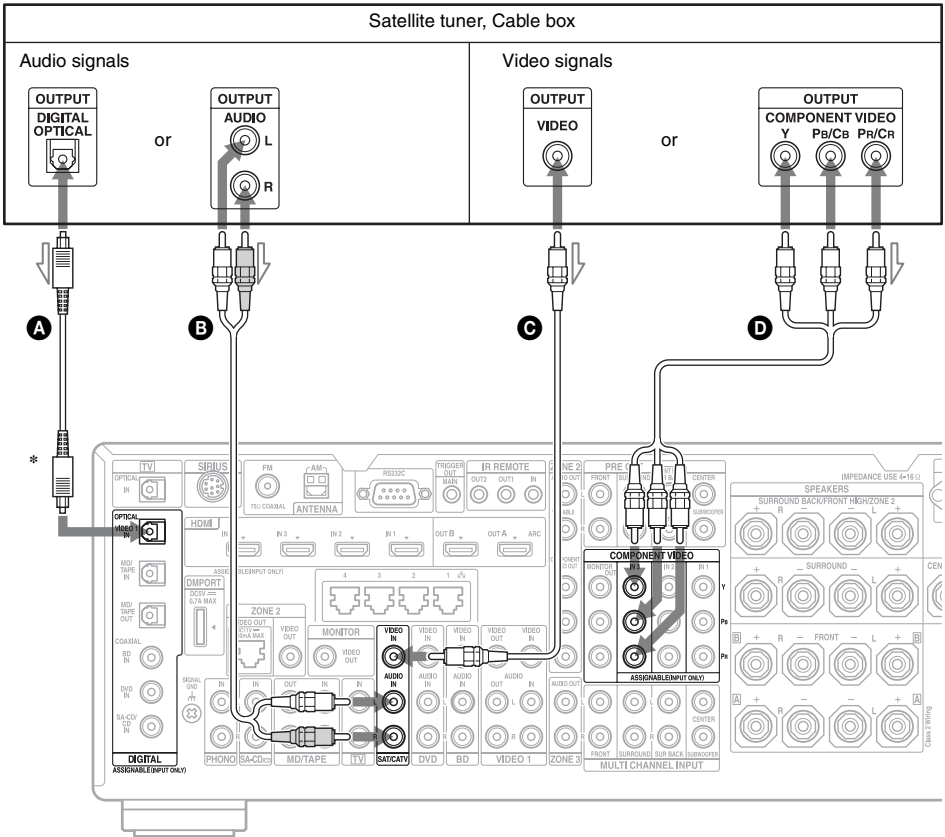

- A** Optical digital cord (not supplied)
- B** Audio cord (not supplied)
- C** Video cord (not supplied)
- D** Component video cord (not supplied)

* When you connect a component equipped with an OPTICAL jack, set "Input Assign" in the Input menu (page 102).

Note

Before connecting cords, make sure to disconnect the AC power cord (mains lead).

To connect a DVD recorder, VCR

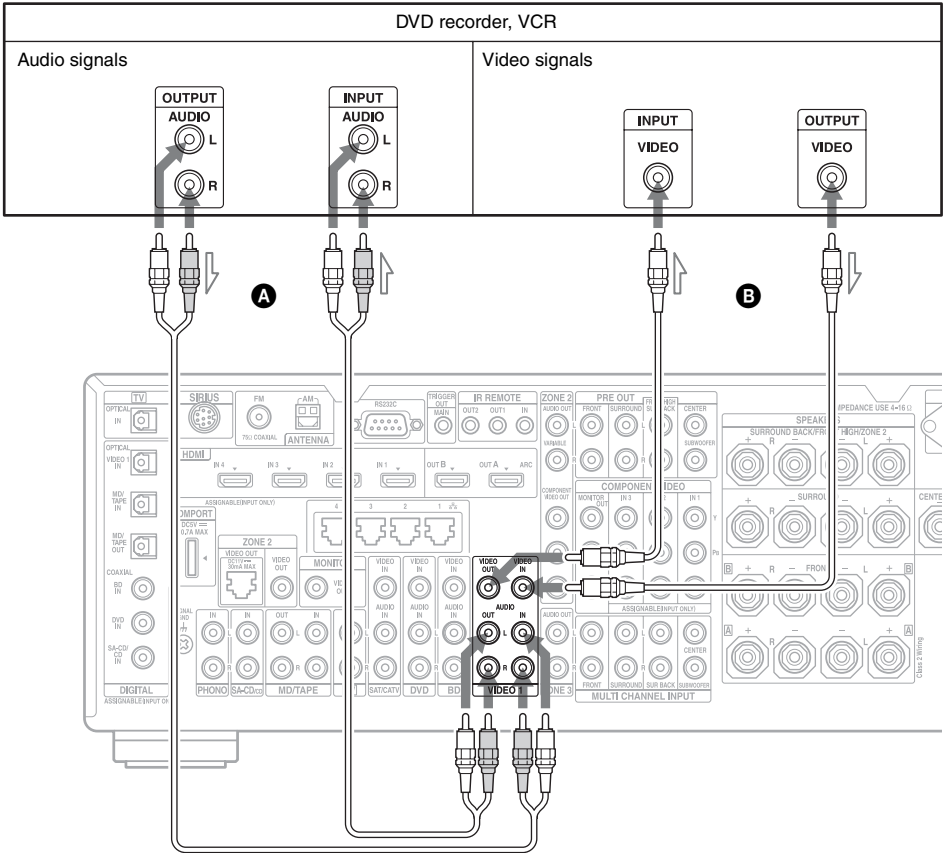

- A** Audio cord (not supplied)
- B** Video cord (not supplied)

To connect a camcorder, video game

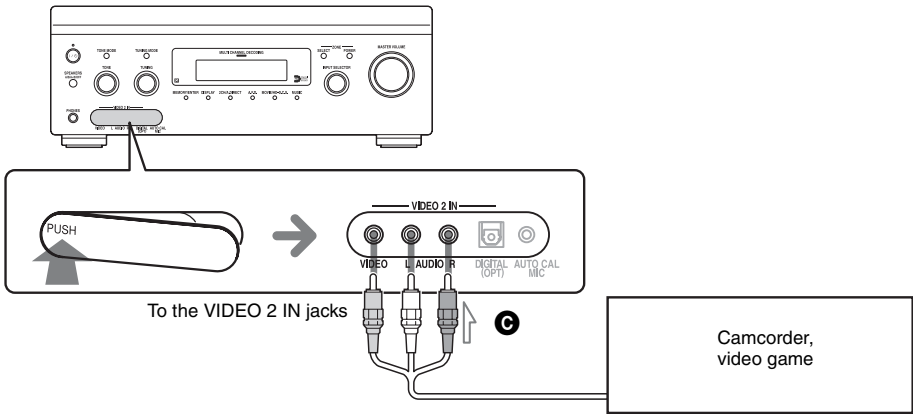

Ⓢ Audio/video cord (not supplied)

Note

Before connecting cords, make sure to disconnect the AC power cord (mains lead).

Function for conversion of video signals

This receiver is equipped with a function for converting video signals.

- Composite video signals can be output as HDMI video and component video signals.
- Component video signals can be output as HDMI video and video signals.

As the initial setting, video signals input from the connected component are output to the HDMI OUT or MONITOR OUT jacks as shown in the table below.

We recommend you set the video conversion function to match the resolution of the monitor you are using.

For details on the video converting function, see “Video settings” (page 121).

INPUT jack \ OUTPUT jack	HDMI OUT A/B	COMPONENT VIDEO MONITOR OUT	MONITOR VIDEO OUT
HDMI IN 1/2/3/4*	○	—	—
VIDEO IN	○	○	○
COMPONENT VIDEO IN	○	○	○

○ : Video signals are output.

— : Video signals are not output.

* HDMI video signals cannot be converted to component video signals and video signals.

Notes on converting video signals

- When video signals from a VCR, etc., are converted on this receiver and then output to your TV, depending on the status of the video signal output, the image on the TV screen may appear distorted horizontally or no image may be output.
- The converted video signals are not output from the VIDEO OUT jack.
- When you play a VCR with an image improvement circuit, such as TBC, the images may be distorted or may not be output. In this case, set the image improvement circuit function to off.
- The resolution of the signals output to the COMPONENT VIDEO MONITOR OUT jacks is converted up to 1080i. The resolution of the signals output to the HDMI OUT jacks is converted up to 1080p.
- COMPONENT VIDEO MONITOR OUT jacks have restrictions on resolution when the resolution of video signals protected by copyright technology is converted. The resolution of the signals output to the COMPONENT VIDEO MONITOR OUT jacks is converted up to 480p/576p. The HDMI OUT jacks have no restriction on resolution.
- Video signals for which the resolution has been converted cannot be output from the COMPONENT VIDEO MONITOR OUT jacks or the HDMI OUT jacks simultaneously. The video signals are output from the HDMI OUT jacks when both are connected.
- Set “Resolution” to “AUTO” or “480i/576i” in the Video settings menu to output the video signals from the MONITOR VIDEO OUT, COMPONENT VIDEO MONITOR OUT jacks when both are connected.

To display Closed Caption

Set “Resolution” to “DIRECT” in the Video settings menu when receiving a signal that supports Closed Captions.

Use the same kind of cords for the input/output signals.

To connect a recording component

When recording, connect the recording component to the VIDEO OUT jacks of the receiver. Connect cords for input and output signals to the same type of jack, as VIDEO OUT jacks do not have an up-conversion function.

Note

Signals output from the HDMI OUT or MONITOR OUT jacks may not be recorded properly.

4: Connecting the audio components

Connecting components with digital audio input/output jacks

The following illustration shows how to connect a Super Audio CD player, CD player, an MD deck and DIGITAL MEDIA PORT adapter.

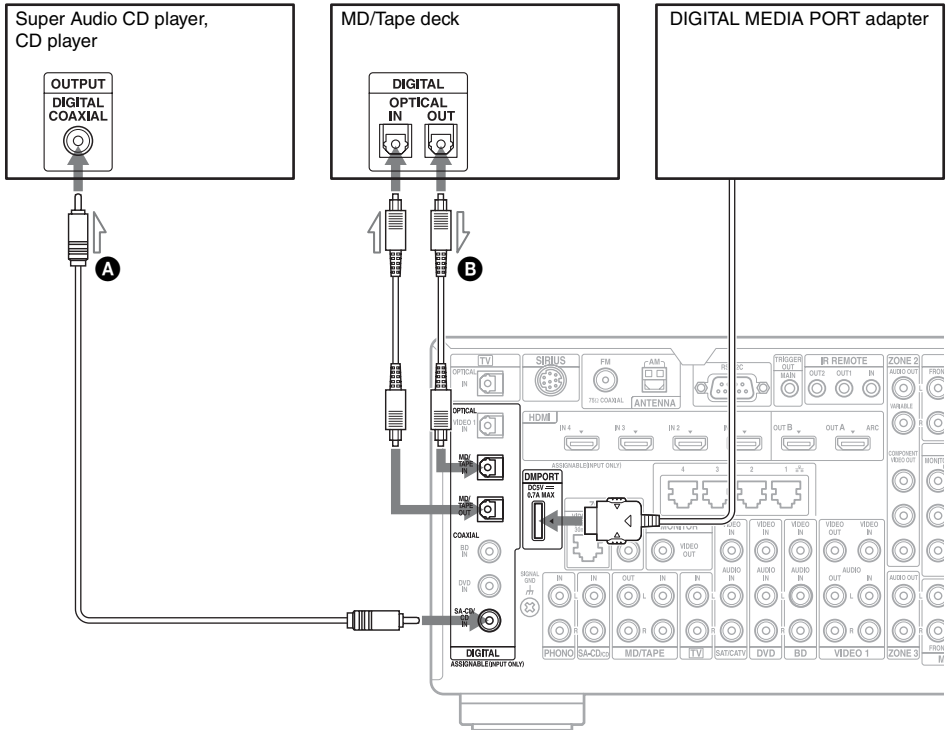

- A** Coaxial digital cord (not supplied)
- B** Optical digital cord (not supplied)

Notes

- When connecting optical digital cords, insert the plugs straight in until they click into place.
- Do not bend or tie optical digital cords.
- To disconnect the DIGITAL MEDIA PORT adapter, remove the DIGITAL MEDIA PORT adapter by squeezing the sides of the connector, since the connector is locked in place.
- Before connecting cords, make sure to disconnect the AC power cord (mains lead).

Tip

All the digital audio jacks are compatible with 32 kHz, 44.1 kHz, 48 kHz, 88.2 kHz and 96 kHz sampling frequencies.

Notes on playing a Super Audio CD on a Super Audio CD player

- No sound is output when playing a Super Audio CD on a Super Audio CD player connected to only the COAXIAL SA-CD/CD IN jack on this receiver. When you play a Super Audio CD, connect the player to the MULTI CHANNEL INPUT or SA-CD/CD IN jacks. Refer to the operating instructions supplied with the Super Audio CD player.
- You cannot make digital recordings of a Super Audio CD.

If you want to connect several digital components, but cannot find an unused input

See “Enjoying the sound/images from other inputs (Input Assign)” (page 102).

Connecting components with multi-channel output jacks

If your Super Audio CD player is equipped with multi-channel output jacks, you can connect them to the MULTI CHANNEL INPUT jacks of this receiver to enjoy multi-channel sound. Alternatively, the multi-channel input jacks can be used to connect an external multi-channel decoder.

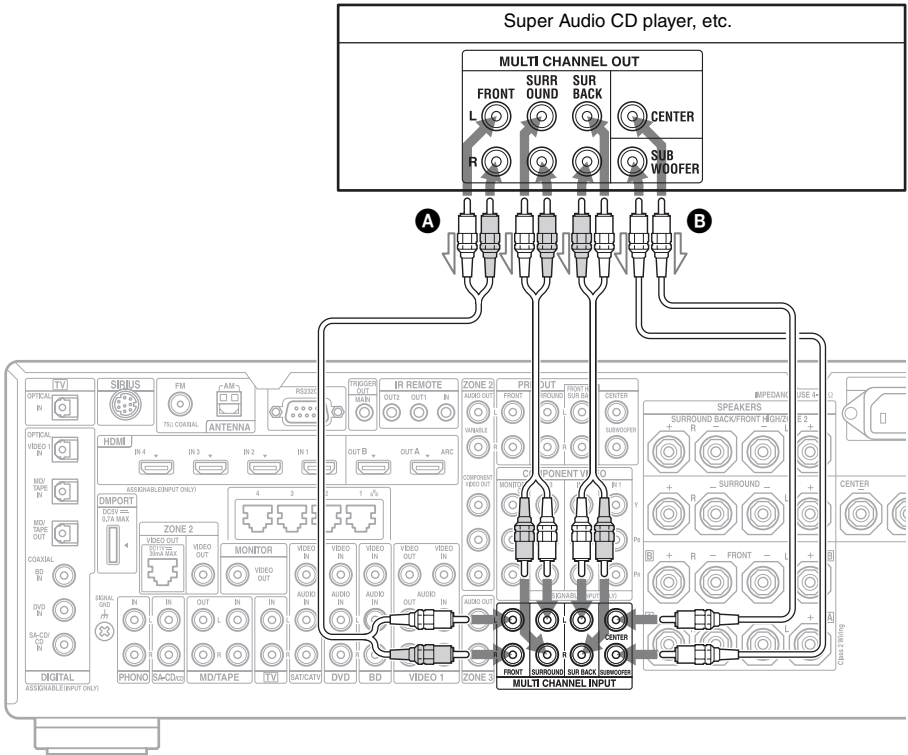

- A** Audio cord (not supplied)
- B** Monaural audio cord (not supplied)

Notes

- Before connecting cords, make sure to disconnect the AC power cord (mains lead).
- Super Audio CD player may not have the SURROUND BACK jacks.
- If the speaker pattern is set so that there are no surround back speakers, the input to the SURROUND BACK jacks is invalid.
- Audio input signals from MULTI CHANNEL INPUT jacks are not output to any audio output jacks. The signals cannot be recorded.

Connecting components with analog audio jacks

The following illustration shows how to connect a component with analog jacks, such as Super Audio CD player, CD player, MD deck, tape deck and turntable, etc.

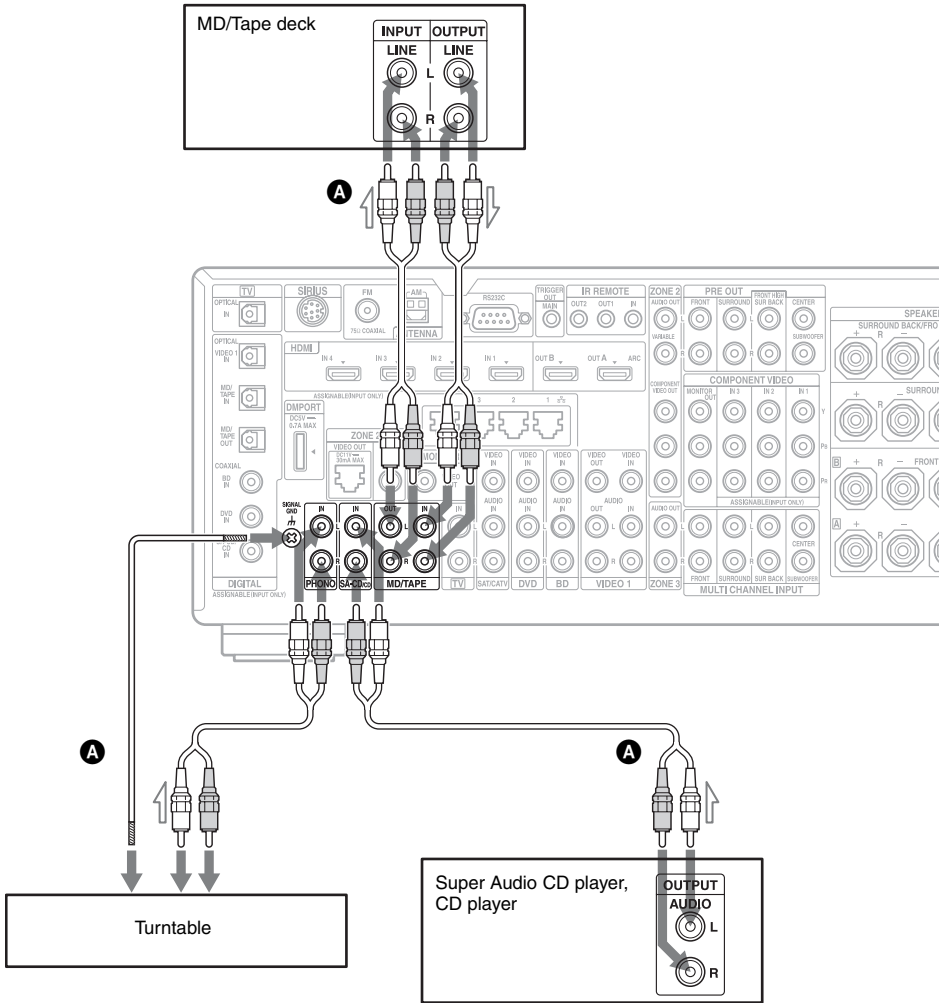

A Audio cord (not supplied)

Notes

- If your turntable has a ground (earth) wire, connect it to the (♯) SIGNAL GND terminal.
- Before connecting cords, make sure to disconnect the AC power cord (mains lead).

5: Connecting the IR Blaster

Attach the supplied IR Blaster to components connected to the receiver. You can control components connected to the receiver via the IR Blaster using the on-screen remote control.

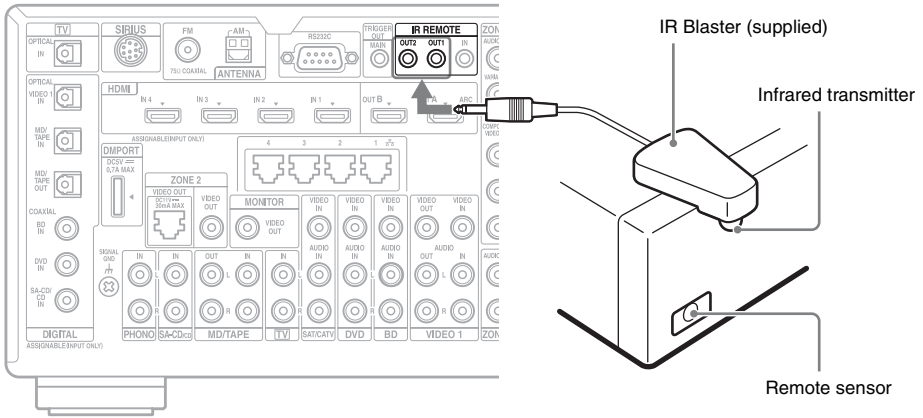

Place the components and the IR Blaster as follows when you want to operate two components with the IR Blaster.

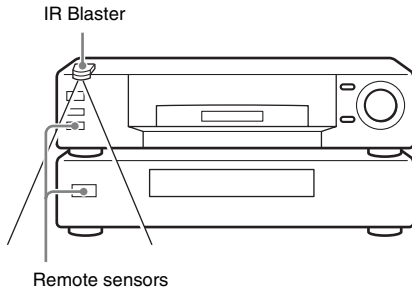

If the infrared receivers on the two components do not line up as shown in the illustration on the left, you must purchase an optional IR Blaster (VM-50, not supplied) and install it.

Note

For details on how to set up a component, refer to the operating instructions of the component.

Tip

If the IR Blaster cable is too short, use a 3.5 mm jack extension cable (not supplied).

After referring to the operating instructions of the components connected to the receiver, make sure to place the IR Blaster just above or below the remote sensor. Remote sensors on Sony Recorders and other products are identified by the  symbol.

Note

Do not remove the backing paper from the IR Blaster yet. After configuring the settings, remove the backing paper from the IR Blaster and fix it in place.

6: Connecting the antennas (aerials)

Connect the supplied AM loop antenna (aerial) and FM wire antenna (aerial).

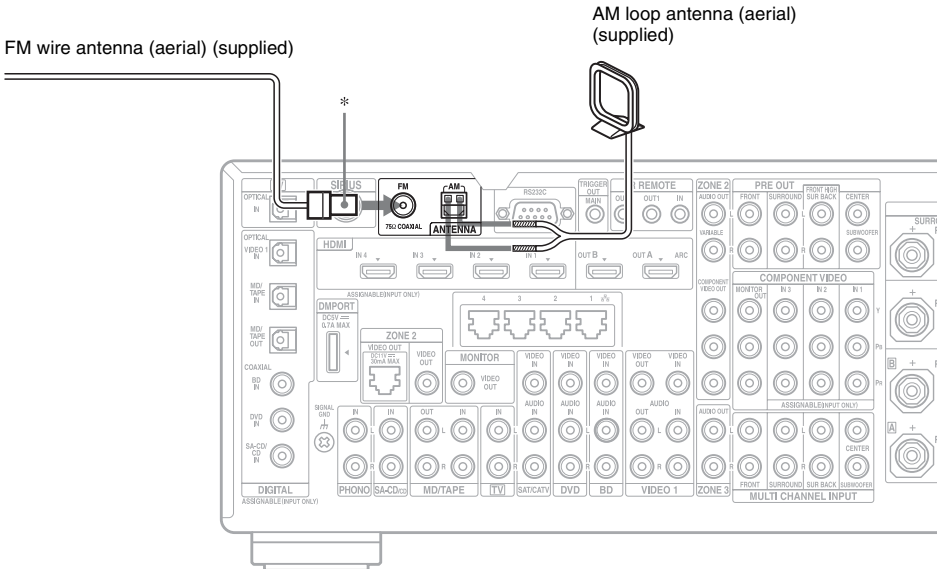

* The shape of the connector varies depending on the area.

Notes

- To prevent noise pickup, keep the AM loop antenna (aerial) away from the receiver and other components.
- Be sure to fully extend the FM wire antenna (aerial).
- After connecting the FM wire antenna (aerial), keep it as horizontal as possible.
- Before connecting cords, make sure to disconnect the AC power cord (mains lead).

7: Connecting to the network

Configuring your home network with DLNA-compliant devices.

If your computer is connected to the Internet, you can connect this receiver to the Internet as well, through the wired LAN connection.

Note

The method used to connect your computer to the Internet depends on the devices, your ISP, your computer, and the router used.

System requirements

The following system environment is required to use the network function of the receiver.

A Broadband line connection

A Broadband line connection to the Internet is required in order to listen to Rhapsody® or SHOUTcast and to use the software update function of the receiver. Rhapsody is only available in the US.

Modem

This is the device that is connected to the broadband line to communicate with the Internet. Some of these devices are integrated with the router.

Router

- Use a router compatible with 100 Mbps or greater transmission speeds to enjoy content on your home network.
- We recommend that you use a router equipped with the built-in DHCP (Dynamic Host Configuration Protocol) server. This function automatically assigns IP addresses on the LAN.

LAN cable (CAT5)

- We recommend that you use this type of cable for a wired LAN. Some flat-type LAN cables are easily affected by noise. We recommend that you use normal-type cables.

- If the receiver is used in an environment in which there is power supply noise from electric products or in a noisy network environment, use a shielded-type LAN cable.

Configuration example

The following illustration is a configuration example of a home network with the receiver, a computer.

We recommend that you use a wired connection.

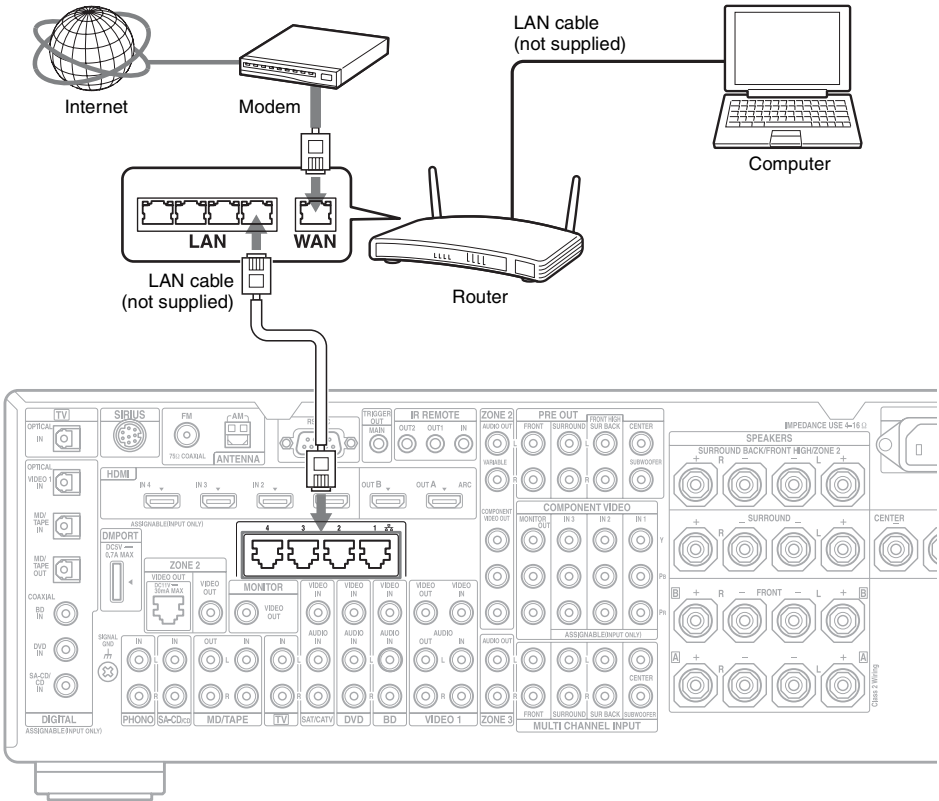

Notes

- A audio or video playback on the computer may occasionally be interrupted when you use a wireless connection.
- Connect a router to one among ports 1 to 4 of the receiver using only one LAN cable. Do not connect the same router to the receiver using more than one LAN cable. It may cause a malfunction.

8: Preparing the receiver and the remote

Connecting the AC power cord (mains lead)

Connect the supplied AC power cord (mains lead) to the AC IN terminal on the receiver, then connect the AC power cord (mains lead) to a wall outlet.

Notes

- Before connecting the AC power cord (mains lead), make sure that metallic wires of the speaker cords are not touching each other between the SPEAKERS terminals.
- Connect the AC power cord (mains lead) firmly.

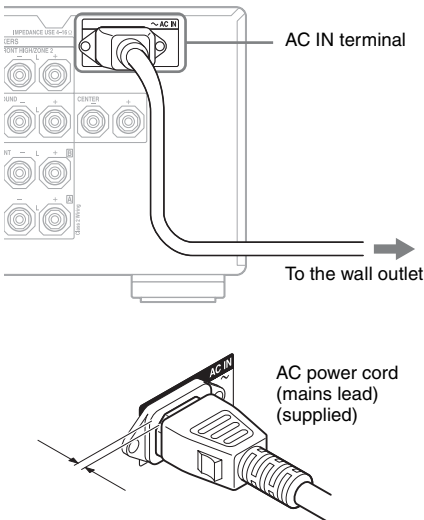

A several space is left between the plug and the rear panel even when the power cord (mains lead) is inserted firmly. The cord is supposed be connected this way. This is not malfunction.

Performing initial setup operations

Before using the receiver for the first time, initialize the receiver by performing the following procedure. This procedure can also be used to return settings you have made to their factory defaults.

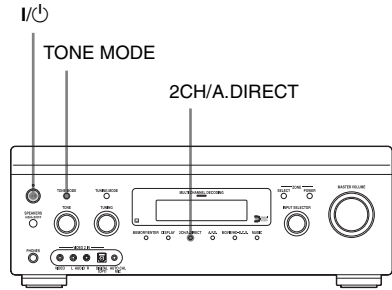

- 1 Press I/O to turn off the receiver.
- 2 While holding down the TONE MODE and 2CH/A.DIRECT, press I/O to turn on the receiver.
- 3 Release the TONE MODE and 2CH/A.DIRECT after a few seconds.

After “CLEARING” appears on the display for a while, “CLEARED !” appears.

All the settings you have changed or adjusted are reset to the initial settings.

Note

It takes about 30 seconds for the memory to be cleared completely. Do not turn the receiver off until “CLEARED !” appears on the display.

To reboot the receiver

If the buttons on the receiver or the remote do not work due to a malfunction of the receiver, reboot the receiver.

- 1 Press I/O to turn off the receiver.

2 Hold down I/⏻ for 10 seconds.

The receiver will be rebooted. When the lamp above I/⏻ flashes in green, the reboot is complete.

Inserting batteries into the remote

Insert two R6 (size-AA) batteries in the RM-AAL034 remote commander, and the RM-AAU061 remote commander.

Observe the correct polarity when installing batteries.

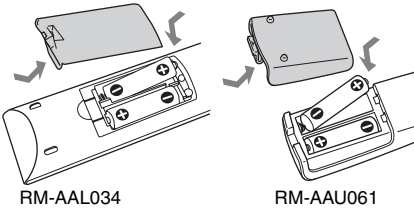

RM-AAL034

RM-AAU061

Notes

- Do not leave the remote in an extremely hot or humid place.
- Do not use a new battery with old ones.
- Do not mix manganese batteries and other kinds of batteries.
- Do not expose the remote sensor to direct sunlight or lighting apparatuses. Doing so may cause a malfunction.
- If you do not intend to use the remote for an extended period of time, remove the batteries to avoid possible damage from battery leakage and corrosion.
- When you replace the batteries, the programmed remote codes may be cleared. If this happens, program the remote codes again (page 147).

Tip

When the remote no longer operates the receiver, replace all the batteries with new ones.

9: Setting the speakers

Setting the speaker impedances

Set the appropriate speaker impedance for the speakers you are using.

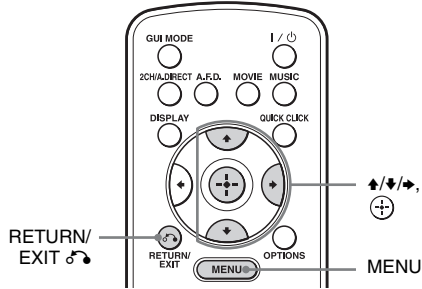

1 Press MENU.

The menu is displayed on the TV screen.

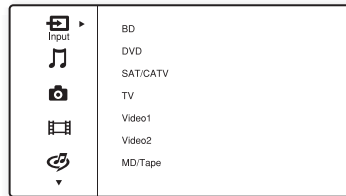

2 Press ↑/↓ repeatedly to select “Settings,” then press ⊕ or →.

The Settings menu list appears on the TV screen.

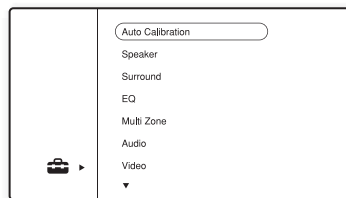

3 Press ↑/↓ repeatedly to select “Speaker,” then press ⊕.

continued

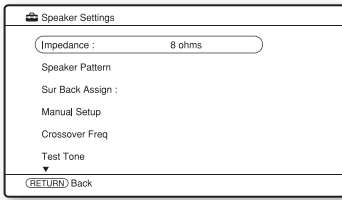

4 Press \uparrow/\downarrow repeatedly to select “Impedance,” then press \oplus .

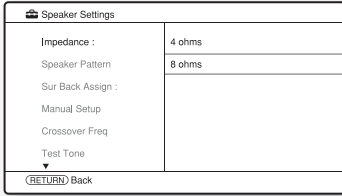

5 Press \uparrow/\downarrow repeatedly to select “4 ohms” or “8 ohms” depending on the speakers you are using, then press \oplus .

The parameter you have selected is entered.

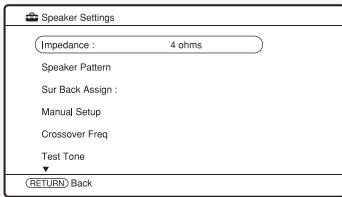

6 Press RETURN/EXIT \rightarrow .

To exit the menu

Press MENU.

Notes

- If you are not sure of the impedances of the speakers, refer to the operating instructions supplied with your speakers. (This information is often on the back of the speaker.)

- When you connect all speakers with a nominal impedance of 8 ohms or higher, set “Impedance” to “8 ohms.” When connecting other types of speakers, set it to “4 ohms.”
- When you connect front speakers to both the FRONT **[A]** and FRONT **[B]** terminals, connect the speakers with a nominal impedance of 8 ohms or higher.
 - When you connect speakers with impedance of 16 ohms or higher in both “**[A]**” and “**[B]**” configuration:
Set “Impedance” to “8 ohms” in the Speaker settings menu.
 - For other types of speakers in other configurations:
Set “Impedance” to “4 ohms” in the Speaker settings menu.

Selecting the speaker pattern

Select the speaker pattern according to the speaker system which you are using.

1 Press MENU.

The menu is displayed on the TV screen.

2 Press \uparrow/\downarrow repeatedly to select “Settings,” then press \oplus or \rightarrow .

The Settings menu list appears on the TV screen.

3 Press \uparrow/\downarrow repeatedly to select “Speaker,” then press \oplus .

4 Press \uparrow/\downarrow repeatedly to select “Speaker Pattern,” then press \oplus .

The Speaker Pattern screen appears.

5 Press \uparrow/\downarrow to select the speaker pattern you want, then press \oplus .

6 Press RETURN/EXIT \rightarrow .

Setting the surround back speakers

You can switch the usage of the speaker(s) connected to the SURROUND BACK/FRONT HIGH/ZONE 2 terminals in accordance with the intended use. Be sure to set “Sur Back Assign” before you perform auto calibration.

1 Press MENU.

The menu is displayed on the TV screen.

2 Press \uparrow/\downarrow repeatedly to select “Settings,” then press \oplus or \rightarrow .

The Settings menu list appears on the TV screen.

3 Press \uparrow/\downarrow repeatedly to select “Speaker,” then press \oplus .

4 Press \uparrow/\downarrow repeatedly to select “Sur Back Assign,” then press \oplus .

5 Press \uparrow/\downarrow repeatedly to select the parameter you want, then press \oplus .

Parameter	Explanation
OFF	The SURROUND BACK/FRONT HIGH/ZONE 2 terminals can be used for a surround back speakers or front high speakers connection.
BI-AMP	The SURROUND BACK/FRONT HIGH/ZONE 2 terminals can also be used for a bi-amplifier connection (page 107).
ZONE2	The SURROUND BACK/FRONT HIGH/ZONE 2 terminals can also be used for a zone 2 connection (page 90).

6 Press RETURN/EXIT \leftarrow .

Note

This setting is available if the speaker pattern is set so that there are no surround back speakers and no front high speakers.

Selecting the front speakers

You can select the front speakers you want to drive.

SPEAKERS (A/B/A+B/OFF)

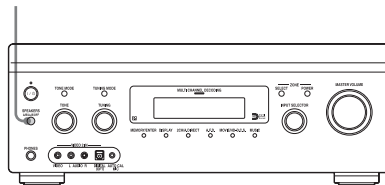

Press SPEAKERS (A/B/A+B/OFF) repeatedly to select the front speaker system you want to drive.

You can confirm which set of terminals (**A** or **B**) are selected by checking the indicators in the display window.

Indicators	Selected speakers
SP A	The speakers connected to the FRONT A terminals.
SP B	The speakers connected to the FRONT B terminals.
SP AB	The speakers connected to both the FRONT A and FRONT B terminals (parallel connection).
	“SPK OFF” appears in the display window. No audio signals are output from any speaker terminals, or the PRE OUT jacks.

Note

This setting is not available when headphones are connected.

10: Calibrating the appropriate speaker settings automatically (Auto Calibration)

The DCAC (Digital Cinema Auto Calibration) function allows you to perform automatic calibration, such as checking the connection between each speaker and the receiver, adjusting the speaker level, and measuring the distance of each speaker from your seating position automatically.

Before you perform auto calibration

- Set up and connect the speakers (page 20-23).
- The AUTO CAL MIC jack is used for the supplied optimizer microphone only. Do not connect other microphones. Doing so may damage the receiver and the microphone.
- During the measurement, the sound that comes out of the speakers is very loud. The volume of the sound cannot be adjusted. Pay attention to the presence of children or to the effect on your neighborhood.
- Perform the measurement in a quiet environment to avoid the effect of noise and get a more accurate measurement.
- If there are any obstacles in the path between the optimizer microphone and the speakers, the calibration cannot be performed correctly. Remove any obstacle from the measurement area to avoid measurement error.

Notes

- In the following situations, the measurements have not been performed correctly or auto calibration cannot be performed.
 - When headphones are connected.
 - When connecting special speakers, such as dipole speakers.

- When using the zone 2/zone 3 function in zone 2/zone 3.
- Cancel MUTING if it is set to on.

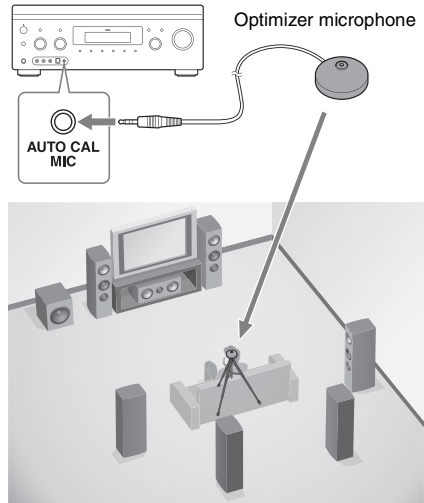

1 Select the speaker pattern (page 43).

If you connect front high speakers, select the speaker pattern that has front high speakers (5/■.■ or 4/■.■) each time you perform auto calibration. Otherwise, the characteristics of the front high speakers cannot be measured.

2 Connect the supplied optimizer microphone to the AUTO CAL MIC jack.

3 Set up the optimizer microphone.

Place the optimizer microphone at your seating position. Use a stool or tripod so that the optimizer microphone remains at the same height as your ears.

On setting up the active subwoofer

- When a subwoofer is connected, turn on the subwoofer and turn up the volume beforehand. Turn the LEVEL knob to just before the mid-point.
- If you connect a subwoofer with the crossover frequency function, set the value to maximum.
- If you connect a subwoofer with an auto standby function, set it to off (deactivated).

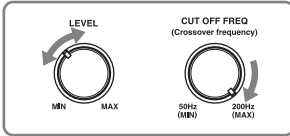

Note

Depending on the characteristics of the subwoofer you are using, the setup distance value may be further away from the actual position.

To use the receiver as a pre-amplifier

You can use the auto calibration function when you use the receiver as a pre-amplifier.

In this case, the distance value shown on the display may differ from the actual distance value. However, there will be no problems, even if you continue to use the receiver with that value.

Performing auto calibration

The auto calibration function allows you to measure the following:

- Speaker connections¹⁾
- Polarity of speakers
- Speaker distance²⁾
- Speaker size²⁾
- Speaker level
- Frequency characteristics (EQ)^{2) 3)}
- Frequency characteristics (Phase)^{2) 4)}

¹⁾The measurement result is not utilized when the multi-channel input is selected.

²⁾The measurement result is not utilized in the following cases.

- The multi-channel input is selected.
- “2ch Analog Direct” is being used.

³⁾The measurement result is not utilized when Dolby TrueHD, or Linear PCM signals with a sampling frequency of 176.4 kHz and higher are being received.

⁴⁾The measurement result is not utilized when signals with a sampling frequency of 88.2 kHz and higher are being received.

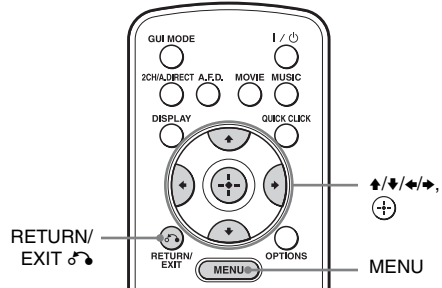

1 Press MENU.

The menu is displayed on the TV screen.

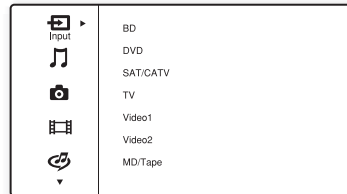

2 Press \uparrow/\downarrow repeatedly to select “Settings,” then press \oplus or \rightarrow .

The Settings menu list appears on the TV screen.

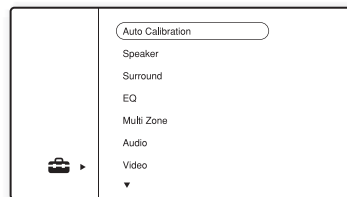

3 Press \uparrow/\downarrow repeatedly to select “Auto Calibration,” then press

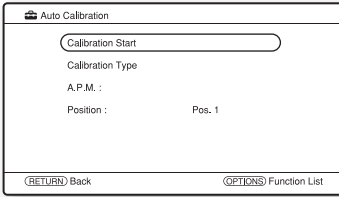

4 Press \uparrow/\downarrow repeatedly to select “Calibration Start,” then press



The screen on which you can select the item to be measured appears.

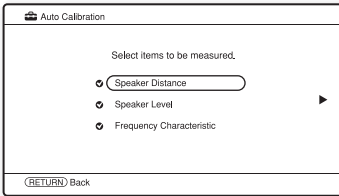

5 Press \uparrow/\downarrow repeatedly and \ominus to un-check the items you do not want to measure, then press \rightarrow .

The confirmation screen, asking whether you are ready to start measurement, appears.

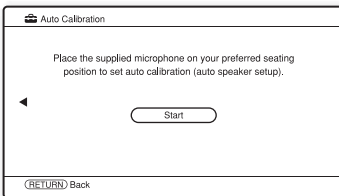

6 Press \ominus to select “Start.”

The measurement starts in five seconds. The measurement process will take approximately 30 seconds with a test

tone. Wait until the measurement process completes.

When the measurement ends, a beep sounds and the screen switches.

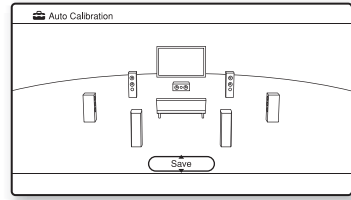

7 Press \uparrow/\downarrow repeatedly to select the item you want, then press



Item	Explanation
Retry	Performs auto calibration again.
Save	Saves the measurement results and exits the setting process. See “Saving the measurement results” (page 49).
Warning	Displays warning concerning the measurement results. See “Message list after auto calibration measurement” (page 50).
Phase	Displays the phase of each speaker (in phase/ out of phase).
Distance	Displays the measurement result for speaker distance.
Level	Displays the measurement result for speaker level.
Exit	Exits the setting process without saving the measurement results.

To save the measurement results, follow the steps in “Saving the measurement results” (page 49).

If you want to check error code or warning message, see “Message list after auto calibration measurement” (page 50).

Note

When the speaker(s) is (are) out of the phase, “OUT” is displayed on the TV screen. The “+” and “-” terminals of the speaker may be connected the other way around. However, depending on the speakers, “OUT” appears on the TV screen even though the speakers are connected properly. This is because of the speakers’ specifications. In this case, you can continue to use the receiver.

Tips

- Operations other than turning the receiver on or off are deactivated during the measurement.
- You can change the unit of distance use in “Distance Unit” in the Speaker settings menu.

To cancel the measurement

The measurement is cancelled when you change the volume, switch functions, change the setting of the SPEAKERS switch, or connect headphones.

Saving the measurement results

To save the measurement results obtained in “Performing auto calibration” (page 47), proceed with the following steps.

- 1 Press \uparrow/\downarrow to select “Save” in step 7 in “Performing auto calibration” (page 47), then press \oplus .**

The selecting screen of the calibration type appears.

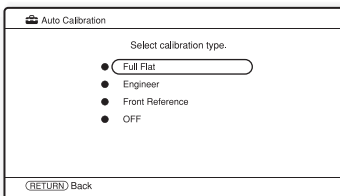

- 2 Press \uparrow/\downarrow repeatedly to select the calibration type, then press \oplus .**

Parameter	Explanation
Full Flat	Makes the measurement of frequency from each speaker flat.
Engineer	Sets the frequency to one that matches that of the Sony listening room standard.
Front Reference	Adjusts the characteristics of all the speakers to match the characteristics of the front speaker.
OFF	Sets the auto calibration EQ to off.

The measurement results are saved.

3 Press RETURN/EXIT \oplus .**Note**

- The frequency response measurement result is not utilized in the following cases.
 - The multi-channel input is selected.
 - “2ch Analog Direct” is being used.
 - Dolby TrueHD, or Linear PCM signals with a sampling frequency of 176.4 kHz and higher are being received.

Tip

The size of a speaker (Large/Small) is determined by the low characteristics. The measurement results may vary, depending on the position of the optimizer microphone and speakers, and the shape of the room. It is recommended that you follow the measurement results. However, you can change those settings in the Speaker settings menu. Save the measurement results first, then try to change the settings if you want.

Checking the auto calibration results

To check error code or warning message obtained in “Performing auto calibration” (page 47), proceed with the following steps.

- Press \uparrow/\downarrow to select “Warning” in step 7 in “Performing auto calibration” (page 47) then press \oplus .**

If a warning message appears, check the message and use the receiver without change. Or if necessary, perform auto calibration again.

When “Error Code” appears

Check the error and perform auto calibration again.

- 1 Press **+** to select “Enter.”
- 2 Press **←/→** to select “Retry,” then press **+**.

- 3 Repeat steps 6 to 7 in “Performing auto calibration” (page 47).

To save measurement results that caused an error without taking a remedy

- 1 Press **↑/↓** to select “Save” in step 7 in “Performing auto calibration” (page 47), then press **+**.
- 2 Follow the steps in “Saving the measurement results” (page 49) to save the measurement results.

Message list after auto calibration measurement

Display	Explanation
Code 30	Headphones are connected. Remove the headphones and perform auto calibration again.
Code 31	SPEAKERS (A/B/A+B/OFF) is set to OFF. Set it to others and re-perform the measurement.
Code 32	None of the speakers were detected. Make sure that the optimizer microphone is connected properly and reperform the measurement. If the optimizer microphone is connected properly but the error code appears, the optimizer microphone cable may be damaged or improperly connected.
Code 33	<ul style="list-style-type: none"> • None of the front speakers are connected or only one front speaker is connected. • The optimizer microphone is not connected. • Either the left or right surround speaker is not connected. • Surround back speakers are connected even though surround speakers are not connected. Connect the surround speaker(s) to the SURROUND terminals. • The surround back speaker is connected only to the SURROUND BACK/FRONT HIGH/ZONE 2 R terminals. When you connect only one surround back speaker, connect it to the SURROUND BACK/FRONT HIGH/ZONE 2 L terminals. • Only one front high speaker is connected. Connect the front high speaker to each of the SURROUND BACK/FRONT HIGH/ZONE 2 terminals. • Front high speakers are connected even though surround speakers are not connected. Connect the surround speaker(s) to the SURROUND terminals.
Warning 40	The measurement has completed. However, the noise level is high. You may be able to perform the measurement properly if you try it again, even though the measurement cannot be performed in all environments. Try to perform the measurement in a quiet environment.
Warning 41	The input from the microphone is too big.
Warning 42	<ul style="list-style-type: none"> • It may be too close the distance between the speaker and the microphone. • Retry the measurement after setting apart from each other. • When you use the receiver as a pre-amplifier, either messages may appear, depending the power amplifier you connect. However, there will be no problems, even if you continue to use the receiver without changes.
Warning 43	The distance and position of a subwoofer cannot be detected. Or the angle of the speaker position cannot be detected. This may be caused by noise. Try to perform the measurement in a quiet environment.
NO WARNING	There is no warning information.
-----	No speakers are connected.

Tip

Depending on the position of the subwoofer, the measurement results for polarity may vary. However, there will be no problems even if you continue to use the receiver with that value.

11: Configuring the network settings of the receiver

The network settings for the receiver must be set correctly to use the network functions of the receiver.

You can make the required network settings for the receiver by following the instructions provided by an initial setup wizard.

The procedure used to set up the IP address automatically (DHCP) is explained below. In this case, the router that is connected to the receiver or the Internet provider must support DHCP.

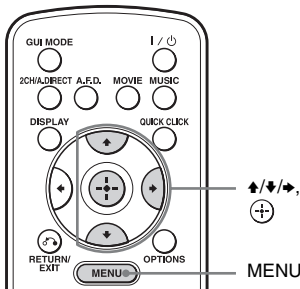

- 1 Press MENU.**
The menu is displayed on the TV screen.
- 2 Press \uparrow/\downarrow repeatedly to select “Settings,” then press \ominus or \rightarrow .**
- 3 Press \uparrow/\downarrow repeatedly to select “Network,” then press \ominus or \rightarrow .**
- 4 Press \uparrow/\downarrow repeatedly to select “Network Setup,” then press \ominus .**
“Start Network function Setup Wizard” appears on the TV screen.
- 5 Press \ominus to select “Next.”**

- 6 Press \ominus to select “Connect Automatically (DHCP).”**

“Success! The receiver is now connected to network.” appears on the TV screen when you have succeeded in making a connection.

If the failure screen is displayed, perform the process referring to “Network Setup” (page 124), after you have completed this process.

- 7 Press \ominus to select “Finish.”**

To set the network settings manually

See “To set the IP address manually” (page 124) or “To set the Proxy server manually” (page 125).

Note

The wizard screen appears on the TV screen each time you use the network function, until the network function setup has been completed.

12: Preparing a computer to use as a server

A server is a device which delivers content (music, photos, and videos) to a DLNA device on a home network.

You can play back content stored on a computer on a home network with this receiver via that network after you have installed application software* which has a DLNA compliant sever function.

* If you use a Windows 7-based computer, use Windows Media Player 12 bundled with Windows 7.

If you use a Windows XP or Windows Vista-based computer, install the VAIO Media plus application software supplied with the receiver. See below for more details on VAIO Media plus. In addition, refer to the help files of VAIO Media plus.

What you can do with VAIO Media plus

VAIO Media plus is an application software that enables you to quickly find content on your home network, such as music, photos, and videos, and view the content on the computer through the home network.

By connecting other devices to VAIO Media plus, you can also find and view the content on the connected devices through the home network. For example, you can enjoy photos and music, stored on your computer, on your TV and audio device or play a TV program, recorded with a hard disk recorder, on your computer.

If you use a VAIO computer, you can deliver content saved on an external hard disk drive or in Network-Attached Storage (NAS).

Note

If you use a computer other than a VAIO, you can only deliver content saved on the internal disk drive of that computer.

System Requirements

Operating System

Windows XP Home Edition/Professional/Media Center Edition 2004/Media Center Edition 2005 (SP3, 32 bit)

Windows Vista Home Basic/Home Premium/Business/Ultimate (SP1, 32 bit/64 bit)

Computer

	Windows XP	Windows Vista
Computer	IBM PC/AT compatible	
CPU	Intel Celeron M processor 1.40 GHz or higher (Intel Core 2 Duo 1.80 GHz or higher is recommended.)	Intel Core Duo 1.33 GHz or higher (Intel Core 2 Duo 2.26 GHz or higher is recommended.)
Memory	512 MB or more (1 GB or more is recommended.)	1 GB or more (2 GB or more is recommended.)

	Windows XP	Windows Vista
Graphic chip	Equipped with graphic chip by Intel, NVIDIA or ATI. DirectX 9.0c compatible video card (DirectX 9.0c/128 MB compatible video card and the latest driver are recommended.)	
Display	800 × 600 or higher resolution	
HDD	500 MB or more is recommended.	
Network	100Base-TX or higher	
Sound card	Direct Sound compatible sound card	

Note

Sony does not guarantee trouble-free operation on all computers that satisfy the system requirements. Other software operating on background may affect the operation of this software.

Installing the VAIO Media plus application software on a computer

When you use VAIO Media plus as server software, install on your computer the VAIO Media plus application software provided on the CD-ROM supplied with the receiver by following steps below.

If an older version of VAIO Media plus has already been installed on your computer, uninstall the following three programs using “Programs and Features” (for Windows Vista) or “Add or Remove Programs” (for Windows XP) in Control Panel beforehand.

- VAIO Media plus
- VAIO Content Folder Watcher
- VAIO Content Folder Setting

1 Turn on your computer and login as an administrator.

2 Insert the supplied CD-ROM into the CD-ROM drive of your computer.

The installation launcher starts automatically, then a Software Setup window appears on the screen. If installation launcher does not start automatically, double-click “SetupLauncher.exe” on the disc.

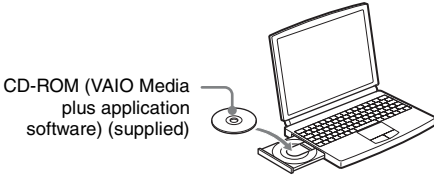

3 Install the VAIO Media plus application software following the instructions given in the message on the screen.

Referring to help files

For VAIO Media plus operations, refer to the help files. Click “ Settings” in the Home Menu window, then select “ Help” to display help files.

Guide to on-screen display operation

You can display the menu of the receiver on the TV screen and select the function you want to use on the TV screen by pressing /// and on the remote.

To display the menu of the receiver on the TV screen, make sure that the receiver is in “GUI MODE” following the step in “To turn “GUI MODE” on and off” (page 55).

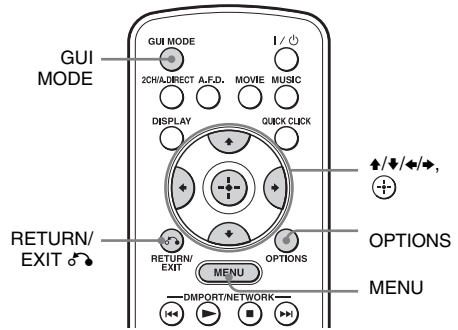

Using the menu

1 Switch the input of the TV so that an image of the menu is displayed.

2 Press MENU.

The menu is displayed on the TV screen.

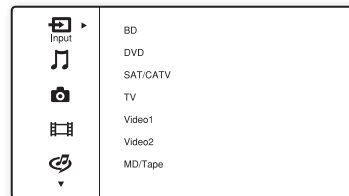

- 3** Press **▲/▼** repeatedly to select the menu you want, then press **⊕** or **▶** to enter the menu mode.

The menu item list appears on the TV screen.

Example: When you select “**Input**”

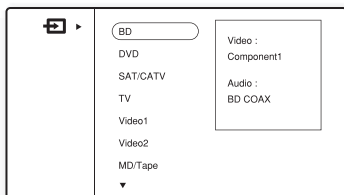

- 4** Press **▲/▼** repeatedly to select the menu item you want to adjust, then press **⊕** to enter the menu item.

- 5** Repeat steps 3 and 4 to select the parameter you want.

To return to the previous screen

Press RETURN/EXIT .

To exit the menu







Press MENU.

To turn “GUI MODE” on and off

Press GUI MODE. “GUI ON” or “GUI OFF” is displayed in the display window of the receiver, depending on the mode selected.

Overview of the main menus

Menu icon	Description
 Input	Selects the input source component connected to the receiver (page 57).

Menu icon	Description
 Music	Selects the music from the server on the home network, “My Library,” or the audio component connected to the DIGITAL MEDIA PORT adapter (page 58).
 Photo	Selects the photos from the server on the home network or “My Library.”
 Video	Selects the images from the server on the home network, “My Library,” or the audio component connected to the DIGITAL MEDIA PORT adapter (page 58).
 Rhapsody	Selects the Rhapsody radio service (page 84). Rhapsody is only available in the US.
 SHOUTcast	Selects the SHOUTcast radio service (page 87).
 FM/AM/SR	Selects the built-in FM/AM radio or satellite tuner connected (page 62, 65).
 Settings	You can adjust the settings of the speakers, the surround effect, equalizer, audio, video and other inputs connected to the HDMI jacks (page 109).

Using the option menus

When you press OPTIONS, the option menus for the selected main menu are displayed. You can select a related function without reselecting the menu.

- 1** Press MENU.

The menu is displayed on the TV screen.

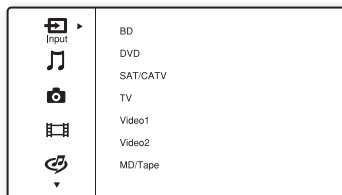

- 2** Press **▲/▼** repeatedly to select a menu you want, then press **⊞** or **▶** to enter the menu mode.

The menu item list appears on the TV screen.

Example: When you select “**Input**”

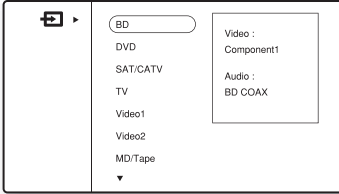

- 3** Press **OPTIONS** while the menu item list is displayed.

The option menu appears.

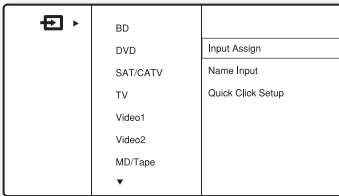

- 4** Press **▲/▼** repeatedly to select the option menu item you want, then press **⊞**.

- 5** Press **▲/▼** repeatedly to select the parameter you want, then press **⊞**.

To exit the option menus

Press **MENU**.

Playback

Enjoying sound/images from the component connected to the receiver

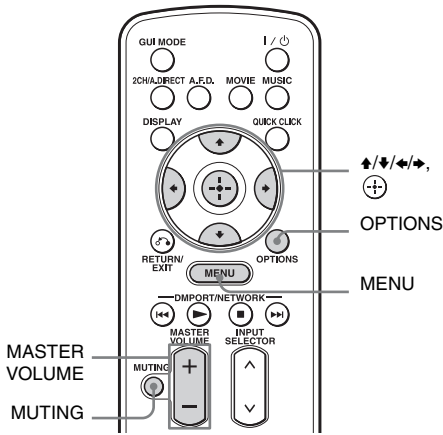

- 1 Select “ Input,” then press or .

The menu item list appears on the TV screen.

- 2 Select the component you want, then press .

The menu screen disappears and the playback screen of the external input appears.

Selected input	Components that can be used
BD	Blu-ray Disc Player, etc., connected to the BD jack.
DVD	DVD player, etc., connected to the DVD jack.
SAT/CATV	Satellite tuner, etc., connected to the SAT/CATV jack.
TV	TV connected to the TV jack.

Selected input	Components that can be used
Video1, Video2	VCR, etc., connected to the VIDEO 1 or VIDEO 2 jack.
MD/Tape	MD or Tape deck, etc., connected to the MD/TAPE jack.
SA-CD/CD	Super Audio CD or CD player, etc., connected to the SA-CD/CD jack.
Phono	Turntable, etc., connected to the PHONO jack.
Multi In	Component connected to the MULTI CHANNEL INPUT jack.
HDMI1, 2, 3, 4	HDMI components connected to the HDMI1, HDMI2, HDMI3, or HDMI4 jack.

- 3 Turn on the component and start playback.
- 4 Press MASTER VOLUME +/- to adjust the volume.

Tips

- You can adjust the volume differently depending on the speed with which you turn the MASTER VOLUME knob.
To turn the volume up or down quickly: turn the knob quickly.
To make fine adjustment: turn the knob slowly.
- You can adjust the volume differently depending on the length of time you press and hold the MASTER VOLUME +/- button on the remote.
To turn the volume up or down quickly: press and hold the button.
To make a fine adjustment: press the button and release it immediately.

To activate the muting function

Press MUTING on the remote. To cancel, press MUTING on the remote again or press MASTER VOLUME + to raise the volume.

To avoid damaging your speakers

Before you turn off the receiver, be sure to turn down the volume level.

Naming the input (Name Input)

You can enter a name of up to 8 characters for inputs and display it.

This is convenient for labeling the jacks with the names of the connected components.



1 Select the input you want to name on the “ Input” screen.

2 Press OPTIONS.

The option menu appears.

3 Select “Name Input,” then press .

4 Press / to select a character, then press .

You can shift input position backward and forward by pressing /.

5 Repeat steps 4 to input a character one by one, then press .

The name you entered is registered.

Enjoying sound/images from the components connected to the DIGITAL MEDIA PORT

The DIGITAL MEDIA PORT is for enjoying sound/images from a portable audio source or computer by connecting a DIGITAL MEDIA PORT adapter.

Available DIGITAL MEDIA PORT adapters vary in each area.

For details on connecting the DIGITAL MEDIA PORT adapter, see “Connecting components with digital audio input/output jacks” (page 34).

You can use the following Sony DIGITAL MEDIA PORT adapters:

- TDM-BT1/BT10 Bluetooth™ Wireless Audio Adapter
- TDM-NW10 DIGITAL MEDIA PORT Adapter
- TDM-iP10/iP50 DIGITAL MEDIA PORT Adapter
- TDM-MP10 DIGITAL MEDIA PORT Adapter

The DIGITAL MEDIA PORT adapter is an optional product.

Notes

- Do not connect an adapter other than the DIGITAL MEDIA PORT adapter.
- Before disconnecting the DIGITAL MEDIA PORT adapter, make sure to turn the receiver off using the remote.
- Do not connect or disconnect the DIGITAL MEDIA PORT adapter to/from the receiver while the system is turned on.
- Depending on the type of DIGITAL MEDIA PORT adapter, the images are also output.
- Do not connect to the receiver a DIGITAL MEDIA PORT adapter that uses a network function such as TDM-NC1 Wireless Network Audio Client.
You can use the network function of the receiver without using a DIGITAL MEDIA PORT adapter.

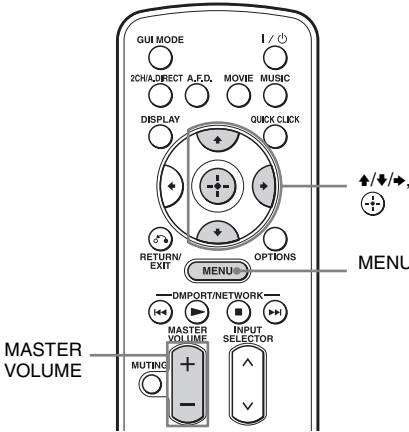

- 1** Select “ Music” or “ Video” from the menu, then press or .
- 2** Select “DMPORNT” or a component connected to the DIGITAL MEDIA PORT adapter, then press .

The component connected to the DIGITAL MEDIA PORT adapter is recognized and “DMPORNT” on the screen will change to the respective component’s name. If the adapter connected cannot be recognized, “DMPORNT” is displayed on the TV screen.

	Component that is connected
DMPORNT	A component other than one of the following is connected.
iPod	The iPod model recognized is connected.
Walkman	The Walkman recognized is connected.
Bluetooth	The Bluetooth drive recognized is connected.
Mobile Phone	The Mobile Phone recognized is connected.

- 3** Select a track you want to play using the component connected to the DIGITAL MEDIA PORT adapter.
- 4** Press MASTER VOLUME +/- to adjust the volume.

Operating the TDM-iP50 using the GUI menu of the receiver

Make sure that “System GUI” is selected in step 4 in “Changing the operation screen using the DIGITAL MEDIA PORT” (page 61).

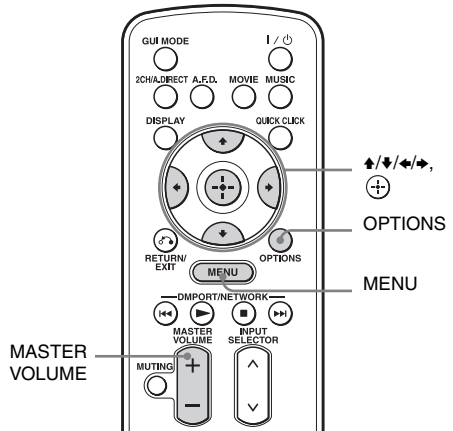

- 1** Select “ Music” or “ Video” from the menu, then press or .
 - 2** Select the component connected to the DIGITAL MEDIA PORT adapter you want to play, then press .
- The contents list appears.

3 Select track or content from the contents list, then press .

The following content lists are just examples. They may vary depending on the components connected to the receiver.

Music — Playlists > Playlist > Track
— Artists > Artist > Album > Track
— Albums > Album > Track
— Songs > Track
— Genres > Genre > Artist > Album > Track
— Composers > Composer > Album > Track
— Audiobooks > Track

Video — Movies > Content
— TV Shows > Episode > Content
— Music Videos > Artist > Content
— Video Podcast > Episode > Content

4 Press MASTER VOLUME +/- to adjust the volume.

Selecting the playback mode

1 Play back the track you want to listen to following the steps outlined in “Operating the TDM-iP50 using the GUI menu of the receiver” (page 59).

2 Press OPTIONS.

The option menu appears.

3 Select “Shuffle,” “Repeat,” or “Audiobook Speed,” then press .

4 Select a mode from the following, then press .

■ Shuffle

Plays all the tracks in random order.

- Off
Deactivates the shuffle play mode.
- Albums
Plays all the tracks on an album in random order.
- Songs
Plays all the tracks in “Songs” in random order.

■ Repeat

Plays one or all the tracks repeatedly.

- Off
Deactivates the repeat play mode.
- One
Plays one track repeatedly.
- All
Plays all the tracks repeatedly.

■ Audiobook Speed

Selects the display speed of the Audiobook.





- Low
Slows the display speed.
- Normal
Sets the display speed to standard.
- High
Increases the display speed.

DIGITAL MEDIA PORT message list

Message appears	Explanation
No Adapter	The adapter is not connected.
No Device	There is no device connected to the adapter.
No Audio	No audio file was found.
Loading	The data is being read.
No Item	No item was found.

Changing the operation screen using the DIGITAL MEDIA PORT

You can change the operation screen using the GUI menu. The DMPORT Control mode is supported by the DIGITAL MEDIA PORT adapters like TDM-iP50. This mode is not supported by other adapters.

1 Select the DIGITAL MEDIA PORT adapter you want on the “ Music” or “ Video” screen, then press  or .

2 Press OPTIONS.

The option menu appears.

3 Select “DMPORT Control,” then press .

If “DMPORT Control” is not displayed, refer to the operating instructions supplied with component for details on operating that component.

4 Select the mode you want, then press .

You can select the following modes in this menu;

- System GUI
The list of tracks will be displayed on the GUI screen of the receiver. You can select a track you want and play back it on each GUI screen.
- Adapter GUI
The menu of the adapter will be displayed on the TV screen.
- iPod

To operate the TDM-iP50 using the adapter menu

Make sure that “Adapter GUT” is selected in step 4 in “Changing the operation screen using the DIGITAL MEDIA PORT” (page 61). For details on operating the adapter using the adapter GUI menu, refer to the operating instructions supplied with the adapter you are using.

To operate the TDM-iP50 using the iPod menu

Make sure that “iPod” is selected in step 4 in “Changing the operation screen using the DIGITAL MEDIA PORT” (page 61). For details on operating the iPod, refer to the operating instruction supplied with the iPod.

Tuning

Listening to FM/AM radio

You can listen to FM and AM broadcasts through the built-in tuner. Before operation, make sure you have connected the FM and AM antennas (aerials) to the receiver (page 39).

Tip

The tuning scale for direct tuning is shown below.

• FM band 100 kHz

• AM band 10 kHz*

* The AM tuning scale can be changed (page 63).

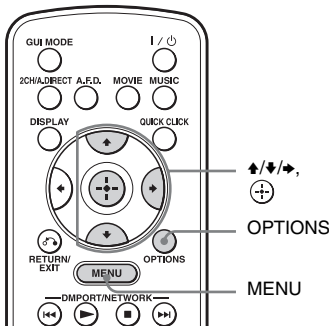

Tuning into a station automatically (Auto Tuning)

- 1 Select “**FM** FM” or “**AM** AM” from the menu, then press \oplus or \rightarrow .

The FM or AM menu list appears on the TV screen.

- 2 Select “Auto Tuning,” then press \oplus .

- 3 Press \updownarrow .

Press \uparrow to scan from low to high, press \downarrow to scan from high to low.

The receiver stops scanning whenever a station is received.

In case of poor FM stereo reception

- 1 Tune in the station you want to listen to using Auto Tuning, Direct Tuning (page 62), or select the preset station you want (page 64).
- 2 Press **OPTIONS**.
The option menu appears.
- 3 Select “FM Mode,” then press \oplus .
- 4 Select “MONO,” then press \oplus .

Tuning into a station directly (Direct Tuning)

Enter the frequency of a station directly by using the numeric buttons on the multifunction remote. This operation cannot be performed using the simple remote.

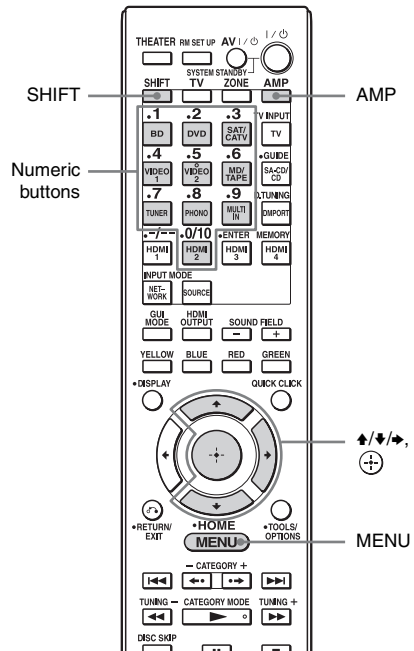

- 1 Press **AMP**.

The receiver can be operated using the remote.

- 2 Press MENU.**
The menu is displayed on the TV screen.
- 3 Press \uparrow/\downarrow repeatedly to select “FM FM” or “AM AM,” then press \oplus or \rightarrow .**
- 4 Select “Direct Tuning,” then press \oplus .**
- 5 Press SHIFT, then press the numeric buttons to enter the frequency, then press \oplus .**
Example 1: FM 102.50 MHz
Select 1 \rightarrow 0 \rightarrow 2 \rightarrow 5
Example 2: AM 1,350 kHz
Select 1 \rightarrow 3 \rightarrow 5 \rightarrow 0

Tip

If you have tuned in an AM station, adjust the direction of the AM loop antenna (aerial) for optimum reception.

If you cannot tune in a station

“----.--- MHz” appears and then the display returns to the current frequency.

Make sure you have entered the right frequency. If not, repeat step 5. If you still cannot tune in a station, the frequency is not used in your area.

- 2 While holding down TUNING MODE, press I/⏻ on the receiver.**
- 3 Change the current AM tuning scale to 9 kHz (or 10 kHz).**

To reset the scale to 10 kHz (or 9 kHz), repeat the procedure above.

Note

All preset stations will be erased when you change the tuning scale.

Changing the AM tuning scale

You can change the AM tuning scale to either 9 kHz or 10 kHz on the receiver.

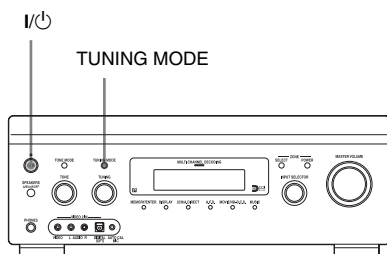

- 1 Press I/⏻ to turn off the receiver.**

Presetting FM/AM radio stations

You can preset up to 30 FM and 30 AM stations. Then you can easily tune in the stations you often listen to.

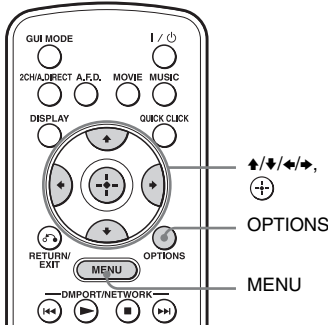

- 1 Tune in the station that you want to preset using Auto Tuning (page 62) or Direct Tuning (page 62).**

In case of poor FM stereo reception, switch the FM reception mode (page 62).

- 2 Press OPTIONS.**
- 3 Select “Memory,” then press ⊕.**

The option menu appears.

- 4 Select a preset number, then press ⊕.**

The station is stored as the selected preset number.

- 5 Repeat steps 1 to 4 to preset another station.**

You can store stations as follows:

- AM band: AM1 to AM30
- FM band: FM1 to FM30

Tuning to preset stations

- 1 Select “ FM” or “ AM” from the menu, then press ⊕ or ↘.**

- 2 Select the preset number station you want.**

Preset numbers from 1 to 30 are available.

Naming preset stations (Name Input)

- 1 Select the preset number on which you want to name on “ FM” or “ AM” screen.**
- 2 Press OPTIONS.**
- 3 Select “Name Input,” then press ⊕.**

The option menu appears.

- 4 Press ↕/↔ to select a character, then press ↘.**

You can shift input position backward and forward by pressing ↔.

- 5 Repeat steps 4 to input a character one by one, then press ⊕.**

The name you entered is registered.

Listening to satellite radio

To listen to Satellite Radio, you'll need to connect a SIRIUS Satellite Radio tuner (sold separately) to your Sirius-Ready receiver. SIRIUS Satellite Radio is available to residents of the US (except Alaska and Hawaii) and Canada.

Satellite Radio delivers a variety of commercial-free music from categories ranging from Pop, Rock, Country, R&B, Dance, Jazz, Classical and many more plus coverage of all the top professional and college sports including play by play games from select leagues and teams. Additional programming includes expert sports talk, uncensored entertainment, comedy, family programming, local traffic and weather and news from your most trusted sources.

Once you've purchased a SIRIUS tuner you'll need to activate it and subscribe to begin enjoying the service. Easy to follow installation and setup instructions are provided with the SIRIUS tuner. There are a variety of programming packages available, including the option of adding "The Best of XM" programming to the SIRIUS service. The "Best of XM" service is not available to SIRIUS Canada subscribers at this time. Please check with SIRIUS Canada for any updates using the numbers and web address below.

Family friendly packages are also available to restrict channels featuring content that may be inappropriate for children.

To subscribe to SIRIUS, U.S. and Canadian customers can call 1-888-539-SIRI (1-888-539-7474) or visit sirius.com (US) or siriuscanada.ca (Canada).

SIRIUS and all related marks and logos are trademarks of Sirius XM Radio Inc. and its

subsidiaries. All other marks and logos are the property of their respective owners. All rights reserved. SIRIUS subscription sold separately. Taxes and a one-time activation fee may apply. SIRIUS tuner required (sold separately) to receive the SIRIUS service. All programming and fees subject to change. It is prohibited to copy, decompile, disassemble, reverse engineer, hack, manipulate or otherwise make available any technology or software incorporated in receivers compatible with the SIRIUS Satellite Radio System. **Service not available in Alaska or Hawaii.**

Connecting a satellite radio tuner

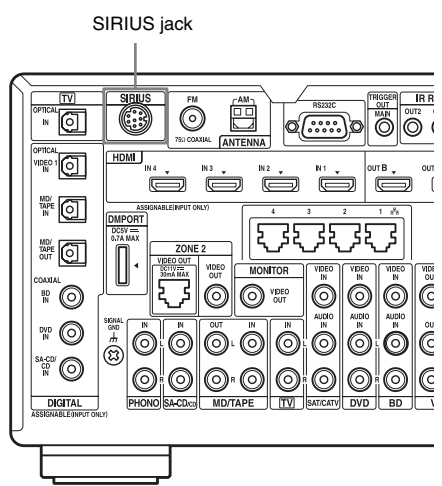

To connect to the SIRIUS jack

Connect the SiriusConnect Home tuner. When you use the SiriusConnect Home tuner with this receiver, be sure to connect the AC power adaptor supplied with the tuner to a wall outlet. Keep the SiriusConnect Home tuner, antenna, and AC power adaptor away from the speaker cords and the power cord to avoid picking up noise.

Preparing to listen to a satellite radio

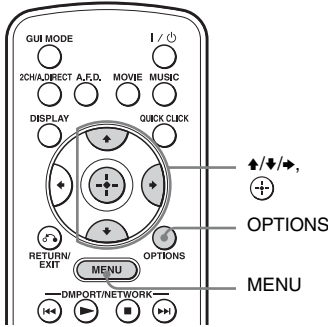

2 Press **OPTIONS**.

The option menu appears.

3 Select “Antenna Aiming,” then press **+**.

The Antenna Aiming screen appears.

4 While checking the quality of the reception, adjust the direction of the antenna to obtain the best reception.

To exit the menu

Press **MENU**.

Checking the ID number

1 Select “**SR SR**” from the menu, then press **+** or **→**.

2 Select “**ALL**,” then press **+**.

When the “Preset Mode” screen is displayed, change the tuning mode to “Category Mode,” then select “ALL.” Press **OPTIONS**, then select “Category Mode.”

3 Select “**Sirius ID**,” then press **+**.

4 Check the Sirius ID on the TV screen and write it in the space provided here.

Sirius ID: _____

You can also check the Sirius ID using the display on the receiver.

Checking receiving conditions (Antenna Aiming)

1 Select “**SR SR**” from the menu, then press **+** or **→**.

Selecting a channel of the satellite radio

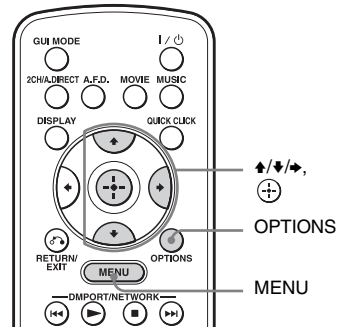

Selecting a channel by category (Category Mode)

You can select a channel from one category or all the categories.

1 Select “**SR SR**” from the menu, then press **+** or **→**.

2 Select the category, then press **+**.

- **ALL**: You can select a channel from all the categories.

- (category name): You can select a channel from one category.
- When the “Preset Mode” screen is displayed, press **OPTIONS**, then press **▲/▼** repeatedly to select “Category Mode.”

3 Select the channel, then press



The selected channel is being received.
The channel information is displayed on the TV screen.

Note

When you select a channel in the “Category Mode,” the channel you selected may not be the one in the category you want. This is because one channel may belong to more than one category.

Selecting a channel by inputting the channel number directly (Direct Tuning)

Enter the channel number directly by using the numeric buttons on the multifunction remote. This operation cannot be performed using the simple remote.

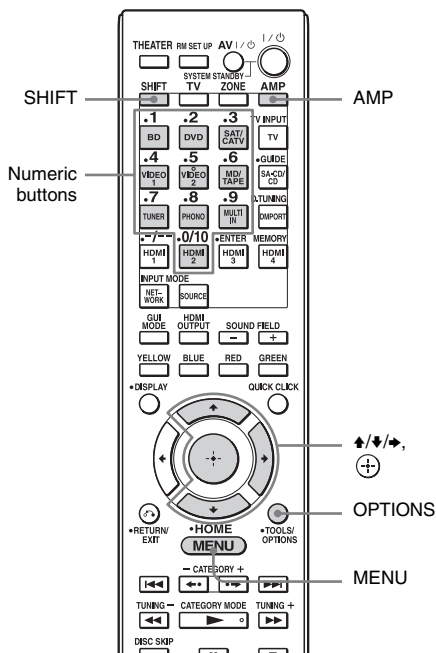

- 1 Press AMP.**
The receiver can be operated using the remote.
- 2 Press MENU.**
The menu is displayed on the TV screen.
- 3 Press ▲/▼ repeatedly to select “SR SR,” then press or .**
- 4 Press OPTIONS.**
The option menu appears.
- 5 Select “Direct Tuning,” then press .**
- 6 Press SHIFT, then press the numeric buttons to enter the channel number, then press .**
The selected channel is tune in.

Presetting satellite radio channels

You can select the channels you want directly by presetting them using the preset numbers. You can preset up to 30 SIRIUS Satellite Radio channels.

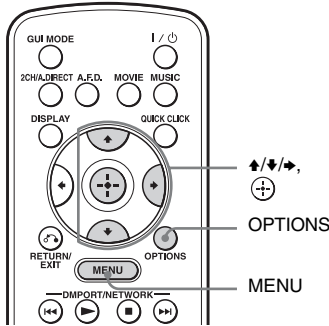

1 Select a channel you want to preset using Category Mode (page 66) or Direct Tuning (page 67).

2 Press **OPTIONS**.

The option menu appears.

3 Select “Memory,” then press **+**.

The preset number selection screen appears.

4 Select the preset number you want to use as the preset channel, then press **+**.

Preset channels from 1 to 30 are available, and a default channel is preset for all the preset channels when you purchase the receiver.

The selected channel is registered as the preset channel you selected in step 1.

5 Repeat steps 1 to 4 to preset another channel.

You can store channels from 1 to 30.

Selecting preset channels

1 Select “**SR** SR” from the menu, then press **+** or **→**.

2 Select the preset number from the preset list, then press **+**.

You can select stored preset channels from 1 to 30.

Notes

- The channel information you have preset may be changed if Sirius XM Radio Inc. change its channel programming.
- When the “Category Mode” screen is displayed, press **OPTIONS**, then press **↑/↓** to select “Preset Mode.”

Restricting access to specific channels (Parental Lock)

You can restrict access to certain channels using your own lock code. The lock code is set to “0000” as the default. Use the multifunction remote for this operation. This operation cannot be performed using the simple remote. Change the lock code before you use this function for the first time. See “To change the lock code (Lock Code)” (page 69).

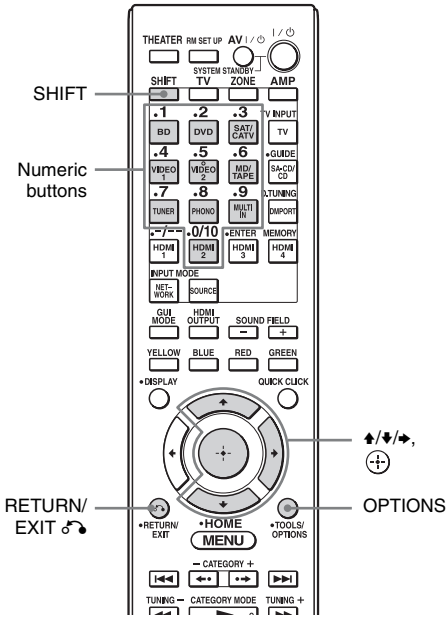

- 1** Select a channel you want to lock using **Category Mode** (page 66) or **Direct Tuning** (page 67).
- 2** Press **OPTIONS**.
The option menu appears.
- 3** Select “Parental Lock,” then press **+** or **→**.
- 4** Select “ON,” then press **+**.
“Enter your 4-digit lock code.” appears.
- 5** Press **SHIFT**, then enter your 4-digit lock code using the numeric buttons.
“The channel has been locked.” appears and the Parental Lock is set.
To delete the numbers you have entered, go back to step 2 by pressing **RETURN/EXIT**, and then repeat the procedure above from step 2.

To change the lock code (Lock Code)

- 1** Select any channel using **Category Mode** (page 66) or **Direct Tuning** (page 67).
- 2** Press **OPTIONS**.
The option menu appears.
- 3** Select “Lock Code,” then press **+**.
“Enter your 4-digit lock code.” appears.
- 4** Press **SHIFT**, then enter your 4-digit lock code using the numeric buttons.
“Enter a new lock code.” appears.
- 5** Press **SHIFT**, then enter a new 4-digit lock code using the numeric buttons.
“To confirm, enter your new lock code again.” appears.
- 6** Press **SHIFT**, then reenter the new lock code with the numeric buttons.
“The lock code has been changed.” appears.

To listen to the locked channels

- 1** Select a locked channel you want to listen to using **Direct Tuning** (page 67).
“Enter your 4-digit lock code.” appears.
- 2** Press **SHIFT**, then enter your 4-digit lock code using the numeric buttons.
The channel is tuned in.

To cancel the Parental Lock

- 1** Select a channel you want to unlock using **Direct Tuning** (page 67).
- 2** Press **OPTIONS**.
The option menu appears.
- 3** Select “Parental Lock,” then press **+** or **→**.
- 4** Select “OFF,” then press **+**.
“Enter your 4-digit lock code.” appears.
- 5** Press **SHIFT**, then enter your 4-digit lock code using the numeric buttons.

“The channel has been unlocked.” appears and the channel is unlocked.

Notes

- You can set only one lock code on the receiver. You cannot set individual lock codes for each channel.
- When you select a channel using Category Mode, locked channels are skipped.
- When the receiver is reset to the factory settings, the lock code returns to the default (0000), but the Parental Lock settings are not removed.
- You cannot preset locked channels. If you set the Parental Lock for a preset channel, the preset information for that channel returns to the default.
- You cannot set the Parental Lock for channel 0 or channel 184.

Message list

Message appears in GUI menu [Display window]	Explanation	Remedies
Antenna Error [ANTENNA ERROR]	The antenna is not connected properly.	Check the connection between the SiriusConnect Home tuner and the antenna.
Acquiring Signal [ACQUIRING]	The receiving condition is not good.	Try moving the antenna to another location. For details about the antenna location, refer to the instructions supplied with the SiriusConnect Home tuner.
CALL 888-539-SIRI [CALL 888-539-SIRI]	You have not subscribed for the selected channel.	—
Check Sirius Tuner [SR TUNER]	The SiriusConnect Home tuner is not connected properly.	Check all the connections, and then turn the system on again. Also make sure if the AC adaptor supplied with the SiriusConnect Home tuner is connected to a wall socket.
Invalid Channel [INVALID CHANNEL]	You have entered an invalid channel number.	The channel to be tuned in is void due to the change by the broadcast service, or the receiving condition is not good.
Locked Channel [LOCKED CH]	The selected channel is locked.	—
Sub Updated [SUB UPDT]	The subscription information has been updated.	—
Updating [UPDATING]	Channel information is being updated.	—
FW Updating [FW UPDT]	The SiriusConnect Home tuner software is being updated.	—
[-----]	There is no text information in the channel.	This is not an error. The text information may not be displayed depending on the system condition, for example, right after the system has received a channel.

Playing back with 2-channel sound

You can switch the output sound to 2-channel sound regardless of the recording formats of the software you are using, the playback component connected, or the sound field settings of the receiver.

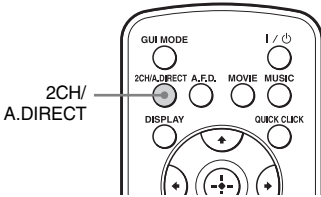

Press 2CH/A.DIRECT repeatedly to select the 2-channel sound mode of the sound output you want.

2CH mode	Effect
2ch Stereo	The receiver outputs the sound from the front left/right speakers only. There is no sound from the subwoofer. Standard 2 channel stereo sources completely bypass the sound field processing and multi-channel surround formats are downmixed to 2 channel.
2ch Analog Direct	You can switch the audio of the selected input to 2 channel analog input. This function enables you to enjoy high quality analog sources. When using this function, only the volume and front speaker level can be adjusted.

To listen to music through headphones connected to the receiver

Sound field	Effect
Headphone (2ch)	This mode is selected automatically if you use headphones when the mode other than “2ch Analog Direct” is selected. Standard 2 channel stereo sources completely bypass the sound field processing and multi-channel surround formats are downmixed to 2 channels.
Headphone (Direct)	Outputs the analog signals without processing by the tone, sound field, etc.
Headphone (Multi)	This mode is selected automatically if you use headphones when the multi-channel input is selected. Outputs the front analog signals from the MULTI CHANNEL INPUT jacks.

Note

- You cannot select “2ch Analog Direct” in the following cases.
 - When you play back content on devices on a home network.
 - The HDMI input or multi-channel input is selected.

Playing back with multi-channel surround

The Auto Format Direct (A.F.D.) mode allows you to listen to higher fidelity sound and select the decoding mode for listening to a 2 channel stereo sound as multi-channel sound.

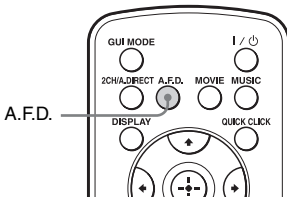

Press A.F.D. repeatedly to select the A.F.D. mode you want.

A.F.D. mode	Multi-channel audio after decoding	Effect
A.F.D. Auto	(Detecting automatically)	Presets the sound as it was recorded/encoded without adding any surround effects.
A.F.D. Multi Stereo	(Multi Stereo)	Outputs 2 channel left/right signals from all speakers.

Notes

- This function does not work when the multi-channel input is selected.
- “Multi Stereo” does not work in the following cases.
 - The multi-channel audio signals are being received.
 - Dolby TrueHD, or Linear PCM signals with a sampling frequency of 176.4 kHz and higher are being received.

Tip

We usually recommend “A.F.D. Auto.”

Enjoying a surround effect for music

You can take advantage of surround sound simply by selecting one of the receiver's pre-programmed sound fields. They bring the exciting and powerful sound of concert halls into your home.

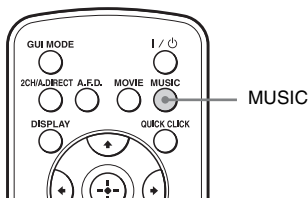

Press MUSIC repeatedly to select the surround effect you want for music.

Sound field	Effect
Hall	Reproduces the acoustics of a classical concert hall.
Jazz Club	Reproduces the acoustics of a jazz club.
Live Concert	Reproduces the acoustics of a 300-seat live house.
Stadium	Reproduces the feeling of a large open-air stadium.
Sports	Reproduces the feeling of sports broadcasting.
Portable Audio	Reproduces a clear enhanced sound image from your portable audio device. This mode is ideal for MP3 and other compressed music.
PLII Music	Perform Dolby Pro Logic II Music mode decoding. This setting is ideal for normal stereo sources such as CDs.
PLIIx Music	Performs Dolby Pro Logic IIx Music mode decoding. This setting is ideal for normal stereo sources such as CDs.
PLIIz Height	Performs Dolby Pro Logic IIz mode decoding. This setting increases flexibility to expand a 5.1 to a 7.1 channel system. Its vertical component gives a dimension of presence and depth. "PLIIz Height" is the same sound field as that is described on page 76. You can adjust the gain level for "PLIIz Height." For details, see "Surround settings" (page 116).
Neo:6 Music	Performs DTS Neo:6 Music mode decoding. A source recorded in 2 channel format is decoded into 7 channels. This setting is ideal for normal stereo sources such as CDs.

To turn off the surround effect for MUSIC

Press 2CH/A.DIRECT or A.F.D.

Notes

- The sound fields for music do not work in the following cases.
 - The multi-channel input is selected.
 - Dolby TrueHD, DTS-HD, or Linear PCM signals with a sampling frequency of 88.2 kHz and higher are being received.
- “PLIImusic,” “PLIImusic,” “PLIImusic,” and “Neo:6 Music” also do not work when the speaker pattern is set to 2/0 or 2/0.1.
- If you set up the sound field during DTS 96/24 signal reception, the signal will be played back only at 48 kHz.
- “PLIImusic,” and “PLIImusic” do not appear depending on the speaker pattern you select.
 - “PLIImusic” is available only when the speaker pattern is set so that there are surround back speaker(s).
 - “PLIImusic” is available only when the speaker pattern is set so that there are front high speakers.
- Some speakers may not output sound, depending on the sound field setting.
- When one of the sound fields for music is selected, no sound is output from the subwoofer if all the speakers are set to “Large” in the Speaker settings menu. However, the sound will be output from the subwoofer if the digital input signal contains L.F.E. signals, or if the front or surround speakers are set to “Small,” the sound field for movie is selected, or “Portable Audio” is selected.
- If there is any noise present, the noise may be different depending on the sound field you select.

Enjoying a surround effect for movies

You can take advantage of surround sound simply by selecting one of the receiver's preprogrammed sound fields. They bring the exciting and powerful sound of movie theaters into your home.

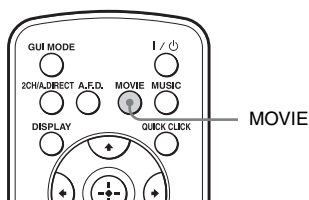

Press MOVIE.

Sound field	Effect
HD-D.C.S.	HD Digital Cinema Sound (HD-D.C.S.) is Sony's new innovative home theater technology using the latest acoustic and digital signal processing technologies. It is based on precise response measurement data of a mastering studio. With HD-D.C.S., you are able to enjoy Blu-ray and DVD movies at home with not only the high quality of sound, but also the best sound ambience, just as the movie's sound engineer intended in the mastering process. You can select the effect type for HD-D.C.S. For details, see "Surround settings" (page 116).
PLII Movie	Performs Dolby Pro Logic II Movie mode decoding. This setting is ideal for movies encoded in Dolby Surround. In addition, this mode can reproduce sound in 5.1 channel for watching videos of overdubbed or old movies.
PLIIx Movie	Performs Dolby Pro Logic IIx Movie mode decoding. This setting expands Dolby Pro Logic II Movie or Dolby Digital 5.1 to discrete 7.1 movie channels.
PLIIz Height	Performs Dolby Pro Logic IIz mode decoding. This setting increases flexibility to expand a 5.1 to a 7.1 channel system. Its vertical component gives a dimension of presence and depth. "PLIIz Height" is the same sound field as that is described on page 74. You can adjust the gain level for "PLIIz Height." For details, see "Surround settings" (page 116).
Neo:6 Cinema	Performs DTS Neo:6 Cinema mode decoding. A source recorded in 2 channel format is decoded into 7 channels.

To turn off the surround effect for MOVIE

Press 2CH/A.DIRECT or A.F.D.









Notes

- The sound fields for movie do not work in the following cases.
 - The multi-channel input is selected.
 - Dolby TrueHD, DTS-HD, or Linear PCM signals with a sampling frequency of 88.2 kHz and higher are being received
- “PLIIMovie,” “PLIIX Movie,” “PLIIZ Height,” and “Neo:6 Cinema” also do not work when the speaker pattern is set to 2/0 or 2/0.1.
- If you set up the sound field during DTS 96/24 signal reception, the signal will be played back only at 48 kHz.
- “PLIIX Movie,” and “PLIIZ Height” do not appear depending on the speaker pattern you select.
 - “PLIIX Movie” is available only when the speaker pattern is set so that there are surround back speaker(s).
 - “PLIIZ Height” is available only when the speaker pattern is set so that there are front high speakers.
- Some speakers may not output sound depending on the sound field.
- If there is any noise present, the noise may be different depending on the sound field you select.

Digital audio formats supported by the receiver

Digital audio formats that this receiver can decode depend on digital audio input jacks for the components connected.

This receiver supports the following audio formats.

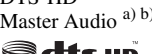
Audio format	Maximum number of channels	Connection of the playback component and the receiver	
		COAXIAL/OPTICAL	HDMI
Dolby Digital 	5.1ch	○	○
Dolby Digital EX 	6.1ch	○	○
Dolby Digital Plus ^{a)} 	7.1ch	×	○
Dolby TrueHD ^{a)} 	7.1ch	×	○
DTS 	5.1ch	○	○
DTS-ES 	6.1ch	○	○
DTS 96/24 	5.1ch	○	○
DTS-HD High Resolution Audio ^{a)} 	7.1ch	×	○
DTS-HD Master Audio ^{a) b)} 	7.1ch	×	○
Multi channel Linear PCM ^{a)}	7.1ch	×	○

^{a)} Audio signals are output in another format if the playback component does not correspond to the format. For details, refer to the operating instructions of the playback component.

^{b)} Signals with a sampling frequency of 176.4 kHz and higher are played back at 96 kHz or 88.2 kHz.

About the network functions of the receiver

- You can enjoy content (music, photos, and videos) which have been stored on a DLNA-compliant device (DLNA CERTIFIED™ Products) that has an authorized DLNA logo displayed on the device (page 80).
- You can use the receiver as a device equivalent to a UPnP media renderer on your home network.
- With an Internet connection, you can listen to Rhapsody and SHOUTcast (page 84, 87) and upgrade the software of the receiver. Rhapsody is only available in the US.
- You can change the settings of the receiver using a computer on your home network (page 88).

About DLNA

DLNA (Digital Living Network Alliance) is a standards organization made up of manufacturers of various products, such as computers, AV components, and mobile computing devices which exchange content (music, photos, and videos). DLNA decides upon standards and publishes an authorized logo to be displayed on devices which support DLNA standards.

Enjoying content stored on the server

A server is a device which delivers content (music, photos, and videos) to a DLNA device on a home network.

You can play back music, photos, and videos stored on the server using the receiver.

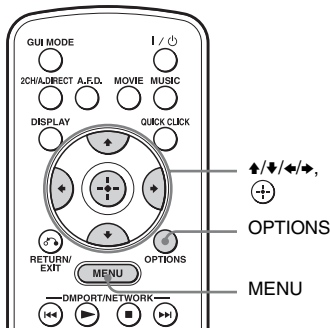
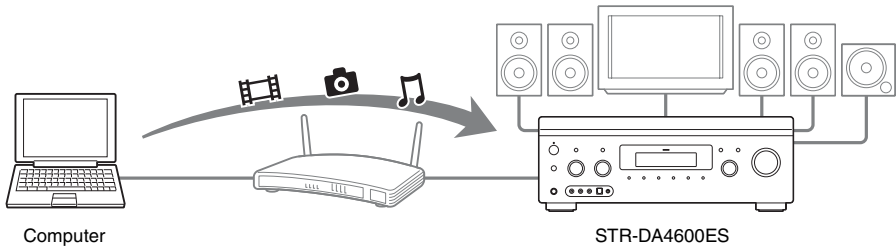

- 1** Select “🎵 Music,” “📷 Photo,” or “🎬 Video” from the menu, then press **⊕** or **➡**.
- 2** Select “Server,” then press **⊕**.
The server list appears on the TV screen.
- 3** Select the server which holds the content you want to play.
The content list appears on the TV screen.
- 4** Select content you want to play from the content list.
The playback screen appears on the TV screen, and content you selected is played back.

To search the server

You can search the server if the server list does not appear on the TV screen.

- 1** Select “🎵 Music,” “📷 Photo,” or “🎬 Video” from the menu, then press **⊕** or **➡**.
- 2** Select “Server,” then press **⊕**.
- 3** Press **OPTIONS**.
- 4** Select “Server Search,” then press **⊕**.
The confirming message appears on the TV screen.
- 5** Select “Yes,” then press **⊕**.
The server list appears on the TV screen.

Registering your favorite content







You can register your favorite content played back from “🎵 Music,” “📷 Photo,” or “🎬 Video,” in “My Library.”

- 1** Press **OPTIONS** while playing back the content.
- 2** Select “Add track (picture, movie) to My Library,” then press **⊕**.

3 Select the number you want to use to register the content from the list, then press .

The content you chose will be registered in “My Library.”

Playing back content registered in My Library

- 1 Select “ Music,” “ Photo,” or “ Video” from the menu, then press  or .
- 2 Select “My Library,” then press .
- 3 Select content you want to play from the content list.

The playback screen appears on the TV screen, and content you selected is played back.











Note

You cannot register content played back from “My Library” in “My Library.”

Using the multifunction remote to play back content

You can enjoy content on the server by using the following buttons on the multifunction remote.



Press AMP to operate the receiver using the remote.

Type of content	 Music	 Photo	 Video
Remote button		●	●
		●	●
		●	●
		●	●
		●	●
		●*	●*
		●*	●*

- * This button may not work depending on the connected server or the type of content.
- ** This button is available when photos are played back in the slideshow mode or from “My Library.”

Selecting the playback mode

You can select the playback mode of the Music category.

- 1 Press **OPTIONS** while the music selections are displayed on the list*, or while listening to the music.
*OPTIONS may not work, depending on the type of content.
- 2 Select “Repeat,” or “Shuffle,” then press .
- 3 Select a mode from the following, then press .

■ Repeat

Plays one or all the tracks repeatedly.

- Off
Deactivates the repeat play mode.
- One
Plays one track repeatedly.
- All
Plays all the tracks repeatedly.

■ Shuffle

Plays all the tracks in random order.

- Off
Deactivates the shuffle play mode.
- On
Activates the shuffle play mode.

To play back a photo together with background music (BGM)

You can enjoy photos with music registered in “My Library” as background music.

- 1 Play back a photo from “Server” (page 80) or “My Library” (page 81).
If you select a photo from “Server,” you will be offered a choice of displaying a single photo or a slideshow of photos on the server.
If you select a photo from “My Library,” photos in “My Library” will be played back in sequence in the slideshow mode.

2 Press **OPTIONS**.

3 Select “BGM,” then press .

4 Select a mode from the following, then press .

- Off
Stops playback of background music.
- On
Plays all the tracks in “My Library” repeatedly.
- On (Shuffle)
Plays all the tracks in “My Library” repeatedly in random order.

Using a controller

You can do the following using a device which has a control function on the home network.

- Playing back content stored on the server with the receiver
- Operating the receiver using Windows 7-based computer with Windows Media Player 12

Note

Before you operate the receiver using a controller, you have to set the controller you want to use to match the receiver. Set “External Control” to “ON,” then set “Controllers” in the Network settings menu. For details on settings for controllers, see “Controllers” (page 125).

Enjoying content stored on the server

You can enjoy, or check the status of content (music, photos, and videos) on the server using a controller. However, only the main zone of the receiver can be operated by a controller.

The following operations are supported.

- Playback, stop, pause, fast-forward and fast-reverse of content
- Go to the next/previous content item
- Checking the elapsed time of the currently playing content

Notes

- Some operations may not be performed, depending on the device used as a controller. For details, refer to the operating instructions of each device.
- If you operate the receiver using the supplied remote together with a controller, the receiver may not work properly.

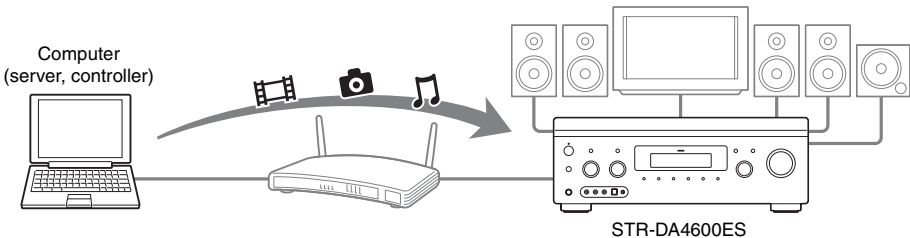

1 Select the device to be used as a server using a controller on the home network.

2 Select the content you want to play back using a controller on the home network.

3 Select the receiver to be used to play back the content using a controller on the home network.

Refer to the operating instructions of each device.

Listening to Rhapsody

You can enjoy the Rhapsody Digital Music Service by connecting your receiver to the Internet.

Rhapsody is only available in the US.

Rhapsody Digital Music Service

Play all the music you want with Rhapsody®

Thousands of artists. Millions of songs. Rhapsody is the critically-acclaimed digital music service that gives you unlimited access to a massive music catalog of millions of songs and thousands of artists. You'll also get exclusive content, personalized recommendations, DJ/ad-free listening on "Rhapsody Radio" and more.

For more information go to:
www.rhapsody.com/sonystr

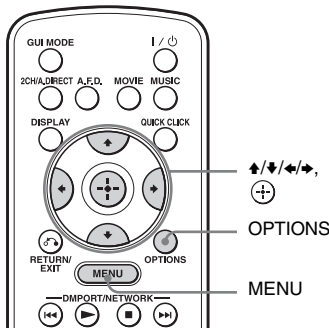

Setting an account

Before using the Rhapsody Digital Music Service, it is necessary to register an account using your computer.

Refer to www.rhapsody.com/sonystr for details.

Sign in using your account on the receiver.

1 Select “ Settings” from the menu, then press \oplus or \rightarrow .

2 Select “Network,” then press \oplus or \rightarrow .

3 Select “Rhapsody Account,” then press \oplus .

The confirmation screen for account input appears on the TV screen.

4 Select “Yes,” then press \oplus .

The account input screen appears on the TV screen.

5 Select the Username box, then press \oplus .

The soft keyboard appears on the TV screen.

6 Press $\uparrow/\downarrow/\leftarrow/\rightarrow$ and \oplus to select a character one by one to enter your user name.

7 Select “Finish,” then press \oplus .

8 Select the Password box, then press \oplus .

9 Press $\uparrow/\downarrow/\leftarrow/\rightarrow$ and \oplus to select a character one by one to enter your password.

10 Select “Finish,” then press \oplus .

11 Select “Finish,” then press \oplus .

Note

Repeat the process again from step 6 if the sign in fails.

To check the account information

1 Select “ Settings” from the menu, then press \oplus or \rightarrow .

2 Select “Network,” then \oplus or \rightarrow .

3 Select “Rhapsody Account,” then press \oplus .

- 4 Press **OPTIONS** to select “Account Information,” then press **(+)**.
The account type and the customer support ID appear on the TV screen.

To delete an account

- 1 Select “**Settings**” from the menu, then press **(+)** or **➔**.
- 2 Select “Network,” then press **(+)** or **➔**.
- 3 Select “Rhapsody Account,” then press **(+)**.
- 4 Press **OPTIONS** to select “Remove Account,” then press **(+)**.
- 5 Select “Yes,” then press **(+)**.
The user name and the password are deleted.

Selecting the station from the Rhapsody Stations list

You can select the station you want to listen using the Rhapsody Stations list.

- 1 Select “**Rhapsody**” from the menu, then press **(+)** or **➔**.
- 2 Select “Rhapsody Radio,” then press **(+)** or **➔**.
- 3 Select the station you want to listen to, then press **(+)**.

The reception screen appears on the TV screen and the station you selected is received.

Note

You can only listen to the same station when listening in the main zone, zone 2, and zone 3 simultaneously.
Priority is given to the station which has most recently been selected, even if other station has already been selected in one of zones.

Selecting the track using Music Guide

The Music Guide displays a variety of music selections to sample, including top tracks and artists, and recommendations.

Select genre names, charts, and new releases anywhere in the Music Guide pages to browse more.

- 1 Select “**Rhapsody**” from the menu, then press **(+)**.
- 2 Select “Rhapsody Music Guide,” then press **(+)**.
- 3 Select “Genres,” “Charts,” “New Releases,” or “Rhapsody Recommends,” then press **(+)** or **➔**.
- 4 Select the track you want to listen to from the list, then press **(+)**.

The playback screen appears on the TV screen and the track you selected is played back.

Note

You can only listen to the same track when listening in the main zone, zone 2, and zone 3 simultaneously. Priority is given to the track which has most recently been selected, even if other track has already been selected in one of zones.





Searching for a track, album, or artist you want to listen to

You can search for a track, album, or artist using the search function.

- 1 Select “**Rhapsody**” from the menu, then press **(+)** or **➔**.
- 2 Select “Search,” then press **(+)** or **➔**.

- 3 Select “Artists,” “Albums,” or “Tracks” you want to search for, then press .

The soft keyboard appears on the TV screen.

- 4 Press  and  to select a character one by one to enter the title or name you want to search for.

- 5 Select “Finish,” then press .

Wait until the search result is displayed.

- 6 Press  to select the search results.

- 7 Select the track you want to listen to from the search result, then press .

The playback screen appears on the TV screen, and track you selected is played back.

Note

You can only listen to the same track when listening in the main zone, zone 2, and zone 3 simultaneously. Priority is given to the track which has most recently been selected, even if other track has already been selected in one of zones.

Registering your favorite track, album, or station

You can register your favorite track, album, or station in “My Library” while playing back the track or during reception.

You can select the track, album or station that you registered in “My Library” from “My Artists,” “My Albums,” “My Genres,” “My Tracks,” “My Playlists,” or “My Stations.”



- 1 Press **OPTIONS** while a track is playing back or you are selecting a station.

- 2 Select “Add track to My Library,” “Add album to My Library,” or “Add station to My Library,” then press .

The track, album, or station you chose will be registered in “My Library.”





To remove a track, album, or station registered in My Library

You can remove a track, album, or station registered in “My Library.”

- 1 Press **OPTIONS** while a track is playing back or you are selecting a station.
- 2 Select “Delete album from My Library,” “Delete track from My Library,” or “Delete station from My Library,” then press .
- The confirmation screen of deletion appears on the screen.
- 3 Select “Yes,” then press .
- The deletion is completed.

Selecting a track, playlist or station registered in My Library

You can select a track, playlist or station registered in “My Library.”

- 1 Select “ Rhapsody” from the menu, then press  or .
- 2 Select “My Library,” then press .
- 3 Select the track you want to listen to using the My Library list, then press .

My Library list

- My Artists > Artist(s)* > Albums(s)* > Track(s)*
- My Albums > Album(s)* > Track(s)*
- My Genres > Genre(s)* > Artist(s)* > Album(s)* > Track(s)*
- My Tracks > Track(s)*
- My Playlists > Playlist(s)* > Track(s)*
- My Stations > Station(s)*

*The number of lists displayed on the screen depends on the status of the Rhapsody Digital Music Service you are using.

The playback screen appears on the TV screen and the track you selected is played back.

Listening to SHOUTcast

SHOUTcast is a digital audio streaming technology-based radio service. SHOUTcast is a directory of Internet radio stations, allowing users to access thousands of free online radio stations from DJs and broadcasters around the world. Refer to <http://www.shoutcast.com> for details.

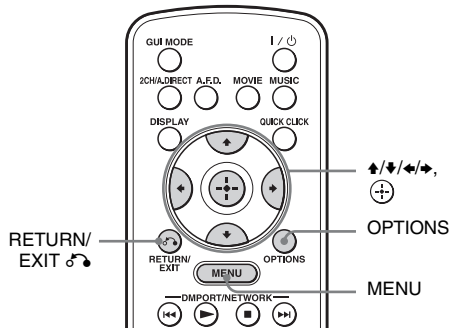

Selecting a SHOUTcast station

- 1 Select “ SHOUTcast” from the menu, then press or .
- 2 Select “Preset List,” “0-9,” or A to Z, then press .
- 3 Select the genre you want to listen to, then press .
- 4 Select the station you want to listen to, then press .

The reception screen appears on the TV screen, and the station you selected is received.

Notes

- When the number of stations is large, up to 100 stations can be displayed (in order) on this receiver.
- The audio supplied in a format that is not supported by this receiver does not appear on the list.
- You can only listen to the same station when listening in the main zone, zone 2, and zone 3 simultaneously.

continued

Priority is given to the station which has most recently been selected, even if other station has already been selected in one of zones.

Presetting favorite stations

You can register your favorite SHOUTcast stations on the receiver.

1 Press OPTIONS while listening to the radio station.

2 Press \oplus to select “Add to Preset List.”

The preset number list appears on the TV screen.

3 Select the preset number you want to preset, then press \oplus .

Note

If you select a list number for which a station has already been registered, the previously registered station will be overwritten.

To return to the previous screen

Press RETURN/EXIT δ .

Selecting preset stations

You can select your favorite stations from among the registered stations.

1 Select “ SHOUTcast” from the menu, then press \oplus or \rightarrow .

2 Select “Preset List,” then press \oplus or \rightarrow .

3 Select the preset number station you want to listen to, then press \oplus .

The reception screen appears on the TV screen, and the station you selected is received.

Features of the Setup Manager application software

You can check the settings of the receiver, and adjust those settings using your computer, as well as using the receiver, after installing the Setup Manager application software provided on the CD-ROM supplied with the receiver.

The following settings cannot be set using the computer with the Setup Manager application software.

- Auto Calibration
- Speaker
 - Test Tone
- Multi Zone
 - Zone Power ON/OFF
 - Zone Input Change
 - Zone Volume Adjust

System Requirements

Operating System

Windows 7 Starter/Home Premium/Professional/Ultimate (32bit/64bit)
Windows Vista Home Basic/Home Premium/Business/Ultimate (SP2, 32bit/64bit)
Windows XP Home Edition/Professional (SP3, 32bit)

Computer

CPU: Celeron, Pentium III or higher
Clock Speed: 1 GHz or higher
RAM: 512 MB or more
HDD: 20 MB or more free disk space (280 MB free disk space is required when .NET Framework 2.0 is not installed.)
Monitor: 1024 × 768, High Color (65536 colors)
Network: 100Base-TX or higher

Installing the Setup Manager application software on a computer

- 1 Turn on your computer and login as an administrator.
- 2 Insert the supplied CD-ROM into the CD-ROM drive of your computer.

The installation launcher starts automatically, then a Software Setup screen appears on the screen.

If the installation launcher does not start automatically, double-click “SetupLauncher.exe” on the disc.

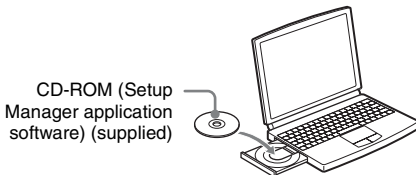

- 3 Install the Setup Manager application software following the instructions given in the message on the screen.

Updating the receiver software using the Setup Manager

You can update the receiver software using the Setup Manager application software provided on the CD-ROM supplied with the receiver. Refer to the HELP of the Setup Manager for details on operations of the Setup Manager. Before updating the receiver software, set “UPDATE(PC)” from “DENY” to “PERMIT” using the display window of the receiver so that the receiver software can be updated using a computer (page 135).

- 1 Download the update program from the support website on the computer to which you installed the Setup Manager.
- 2 Click “System” in the Setup Manager window on the computer screen, then click “Browse...” and specify the path of the update program, and click “Start Update.”

The MULTI CHANNEL DECODING lamp on the front panel flashes while updating.

When the updating complete, the receiver will restart automatically.

Notes

- Do not turn the receiver off or disconnect the network cable during software updating. It may cause a malfunction.
- It may take 50 minutes for the software updating to complete.

To check the HELP

When you want to check the HELP of the Setup Manager application software, click [Start] – [All Programs] – [Setup Manager] – [Help for Setup Manager], in that order.

Using Multi-zone Features

What you can do with the Multi-zone function

You can enjoy images and sounds from a component connected to the receiver in a zone other than the main zone. For example, you can watch the DVD in the main zone and listen to the CD in zone 2 or zone 3.

When using an IR repeater (not supplied), you can operate both a component in the main zone and Sony receiver in zone 2 or zone 3 from zone 2 or zone 3.

Use the multifunction remote in zone 2 or zone 3. You cannot use the simple remote in a zone (zone 2 or zone 3) other than the main zone.

To operate the receiver from zone 2 or zone 3

You can operate the receiver without pointing the remote toward the receiver if you connect an IR repeater (not supplied) to the IR REMOTE jack.

Use an IR repeater when you install the receiver in a place where signals from the remote cannot reach.

Making a multi-zone connection

1:Zone 2 connections

- ① Outputs sound from speakers in zone 2 using the SURROUND BACK/FRONT HIGH/ZONE 2 terminals of the receiver.

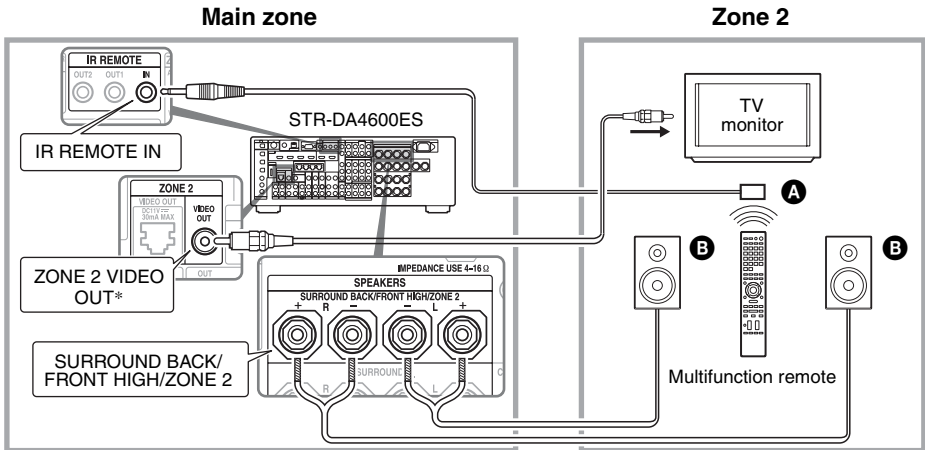

② Outputs sound from speakers in zone 2 using the receiver and another amplifier.

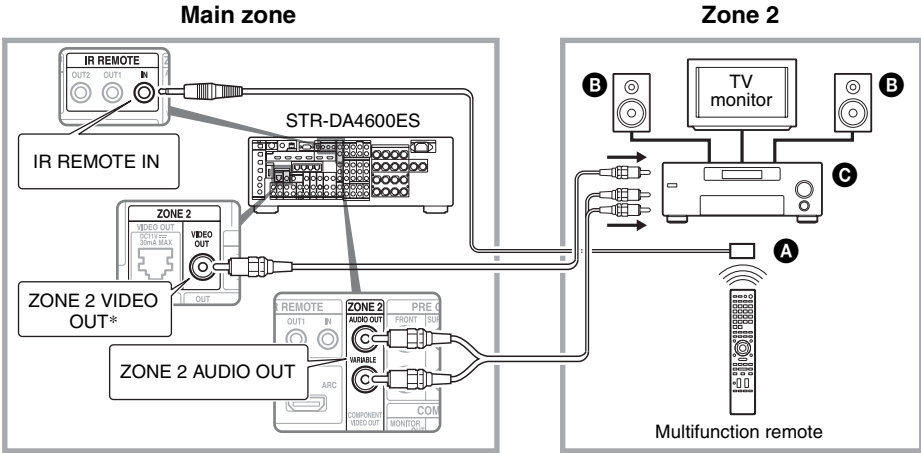

- A** IR repeater (not supplied)
- B** Speakers
- C** Sony Amplifier/Receiver

* You can also connect to the ZONE 2 COMPONENT VIDEO OUT jack.

2:Zone 3 connections

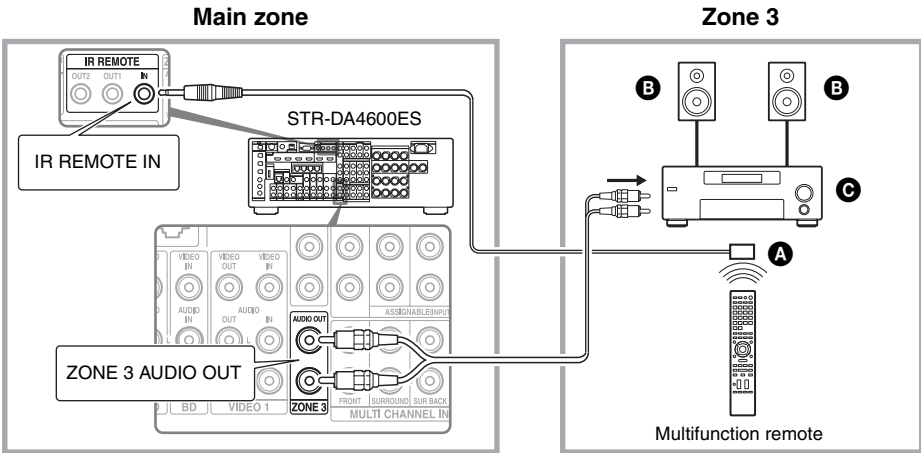

- A** IR repeater (not supplied)
- B** Speakers
- C** Sony Amplifier/Receiver

Making a zone 2 configuration using ZONE 2 VIDEO OUT (RJ-45 jack)

ZONE 2 VIDEO OUT (RJ-45 jack) is used only for custom installation by a qualified person. ZONE 2 VIDEO OUT (RJ-45 jack) is a jack that sends a source video signal to the component video input for zone 2. For details, consult your dealer.

Note

This jack is not for an Ethernet LAN connection.

ZONE 2 VIDEO OUT (RJ-45 jack) connection

The RJ-45 pinouts use the T568B standard.

Refer to the illustration below.

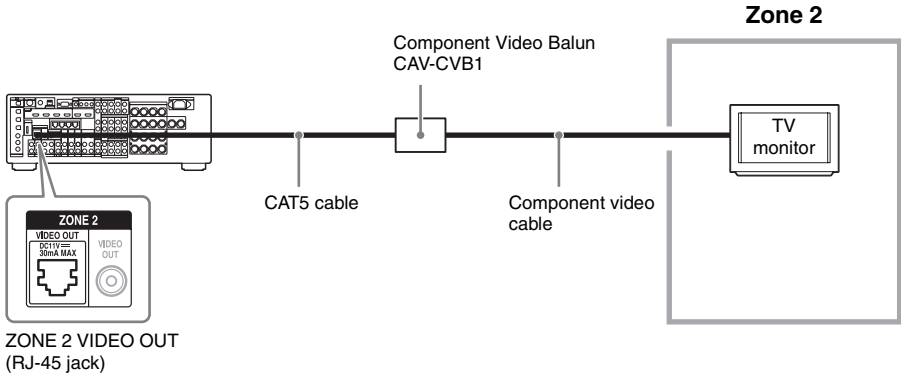

Note

CAV-CVB1 (Component Video Balun) must be used. Other types will cause trouble and may void your warranty.

RJ-45 Video Pinout

The RJ-45 pinouts use the T568B standard.

Refer to the illustration below.

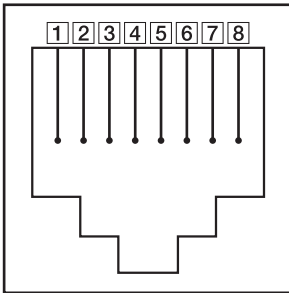

Pinout	Wire color
1 Pin 1	BLUE/Pb (R) White/Orange
2 Pin 2	BLUE/Pb (T) Orange
3 Pin 3	GREEN/Y (R) White/Green
4 Pin 4	GND Blue
5 Pin 5	+11V White/Blue
6 Pin 6	GREEN/Y (T) Green
7 Pin 7	RED/Pr (R) White/Brown
8 Pin 8	RED/Pr (T) Brown

CAT5 cable

Be sure to verify the CAT5 wiring connection is correct.

Use Category 5e or Category 6 cable.

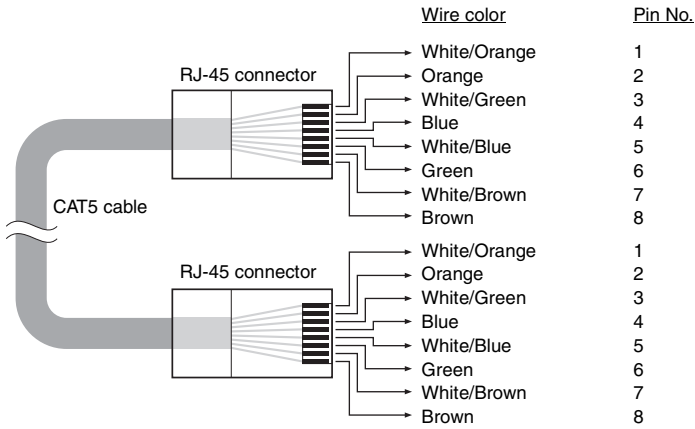

Setting the speakers in zone 2

When the speakers in zone 2 are connected to the SURROUND BACK/FRONT HIGH/ZONE 2 terminals of the receiver (page 90), make the setting so that the sound selected in zone 2 is output from the speakers connected to the SURROUND BACK/FRONT HIGH/ZONE 2 terminals.

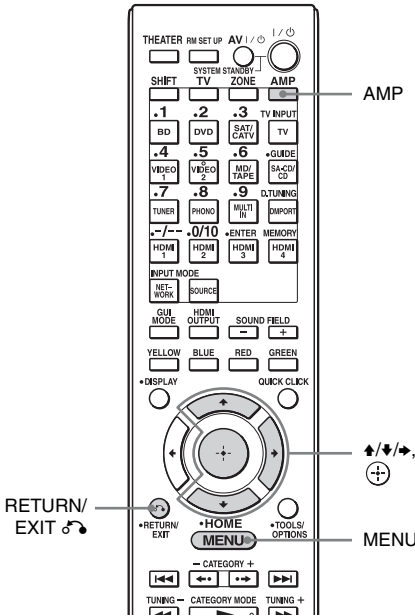

- 1 Press AMP.**
The receiver can be operated using the remote.
- 2 Press MENU.**
The menu is displayed on the TV screen.
- 3 Select “Settings” from the menu, then press \oplus or \rightarrow .**
- 4 Select “Speaker,” then press \oplus or \rightarrow .**

- 5 Select “Speaker Pattern,” to select the pattern that has no surround back speakers or no front high speakers.**
- 6 Press RETURN/EXIT \leftarrow .**
- 7 Select “Sur Back Assign,” then press \oplus .**
- 8 Select “ZONE2,” then press \oplus .**

Note

If the speaker pattern is set so that there are surround back speakers or front high speakers, you cannot make the zone 2 settings.

To exit the menu

Press MENU.

Set the volume control for zone 2

You can set the volume control for the ZONE 2 AUDIO OUT jacks variable or fixed.

- 1 Select “Settings” from the menu, then press \oplus or \rightarrow .**
- 2 Select “Multi Zone,” then press \oplus or \rightarrow .**
- 3 Select “Zone2 Line Out Level,” then press \oplus .**
- 4 Select the parameter you want, then press \oplus .**

Parameter	Explanation
VARIABLE	The volume control is set to -40 dB initially. Recommended when using a power amplifier.
FIXED	The volume control is fixed to ± 0 dB. Recommended when using a component with the variable volume control.

Tip

When you set this item to “VARIABLE,” the volume for the ZONE 2 AUDIO OUT and the ZONE 2 SPEAKERS terminals can be changed in conjunction with each other.

Switching the zone setting of the remote

The remote commander is initially set to be used in zone 2. If you want to use it in zone 3, switch the zone setting of the remote.

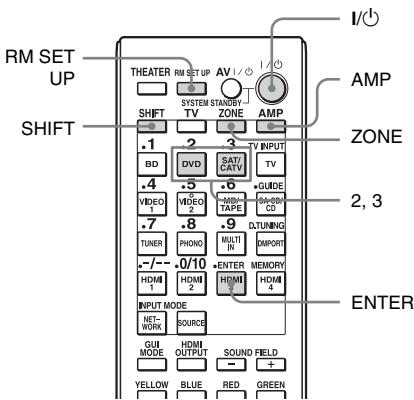

- 1 Press I/⏻ while pressing RM SET UP.**
The AMP and ZONE buttons flash.
- 2 Press ZONE.**
The AMP button goes off, the ZONE button keeps flashing and the SHIFT button lights up.
- 3 Press SHIFT, then press the numeric button 2 for the zone 2, or 3 for the zone 3 while the ZONE button is flashing.**
The ZONE button lights up.
- 4 Press ENTER.**
The ZONE button flashes twice and the remote switches to zone 2 or zone 3 mode.

Operating the receiver from another zone (ZONE 2/ZONE 3 operations)

The following operations are described for connecting an IR repeater and operating the receiver in zone 2 or zone 3. When an IR repeater is not connected, use this receiver in the main zone.

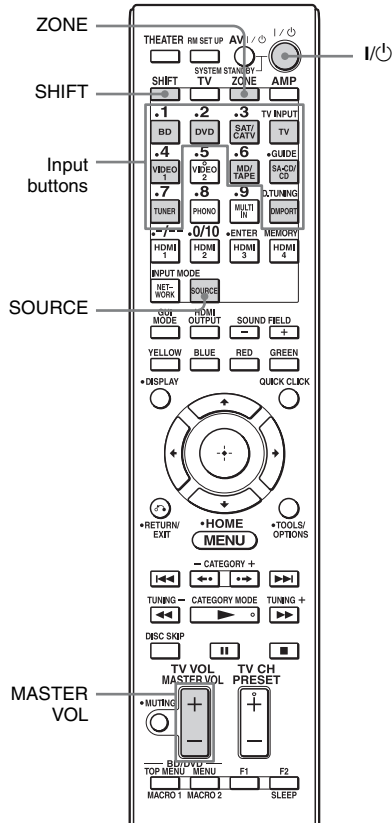

- 1 Turn on the main receiver (this receiver) and the amplifier in zone 2 or zone 3.**

2 Press ZONE.

The remote switches to zone 2 or zone 3. Change the zone setting of the remote to zone 2 or zone 3 in advance (page 95).

3 Press I/⏻.

The zone function is activated.

4 Press one of the input buttons on the remote to select the source signals you want to output.

For zone 2, analog video and audio signals are output. For zone 3, only analog audio signals are output. When you select SOURCE, the signals of the current input in main zone are output.

5 Adjust to a suitable volume.

- In the case of illustration 1-① (page 90), adjust the volume using MASTER VOL +/- on the remote.
- In the case of illustration 1-② (page 91) or 2 (page 91), adjust the volume using the receiver in zone 2 or zone 3. If you set “Zone2 Line Out Level” to “VARIABLE,” you can also adjust the volume using MASTER VOL +/- on the remote (page 94).

- When SOURCE is selected, the signals input to the MULTI CHANNEL INPUT jacks are not output from the ZONE 2 OUT or ZONE 3 OUT jacks even when the multi-channel input is selected.
- The TV input, phono input, or multi-channel input can be selected in the main zone only.
- “Server,” “DMPort,” “Rhapsody,” “SHOUTcast,” “FM,” “AM,” or “SIRIUS” cannot be selected in zone 3.
- You can select either “FM” or “AM” from the main zone and zone 2. Priority is given to the choice which has most recently been selected, even if a different choice has already been selected in one of the zones.
- You can select any one of “Server,” “Rhapsody,” or “SHOUTcast” from the main zone and zone 2. Priority is given to the choice which has most recently been selected, even if a different choice has already been selected in either zone.
- You can select only the same channel from “SIRIUS” when listening in both the main zone and zone 2 simultaneously. Priority is given to the channel which has most recently been selected, even if a different channel has already been selected in either zone.

To finish the zone 2/zone 3 operation

Press ZONE, then press I/⏻.

Tips

- Even when this receiver is standby mode (press I/⏻ on the remote to turn off this receiver), the receiver in zone 2 or zone 3 remains turned on. To turn off all receivers, press I/⏻ and AV I/⏻ on the multifunction remote at the same time (SYSTEM STANDBY).
- Only signals from components connected to the analog input jacks are output through the ZONE 2 OUT/ZONE 3 OUT jacks. No signals are output from components connected to only the digital input jacks.

Using Other Features

Using “BRAVIA” Sync features

What is “BRAVIA” Sync?

“BRAVIA” Sync is compatible with a Sony TV, Blu-ray Disc/DVD player, AV amplifier, etc., that is equipped with the Control for HDMI function.

By connecting Sony components that are compatible with the “BRAVIA” Sync with an HDMI cable (not supplied), operation is simplified as below:

- One-Touch Play (page 98)
- System Audio Control (page 98)
- System Power-Off (page 99)
- Theater Mode Sync (page 99)

Control for HDMI is a mutual control function standard used by HDMI CEC (Consumer Electronics Control) for HDMI (High-Definition Multimedia Interface).

The Control for HDMI function does not work in the following cases:

- When you connect the receiver to a component which is not correspond with Sony Control for HDMI function.
- When you connect the receiver and components using other than HDMI connection.
- The Control for HDMI function does not work on a component connected to the HDMI OUT B jack of the receiver.

We recommend that you connect the receiver to products featuring “BRAVIA” Sync.

Note

Depending on the connected component, the Control for HDMI function may not work. Refer to the operating instructions of the component.

Preparing for the “BRAVIA” Sync

To use the “BRAVIA” Sync, turn the Control for HDMI function on for both the receiver and the connected component.

Turn the Control for HDMI function of the receiver and the connected component on individually.

Use the multifunction remote for this operation. This operation cannot be performed using the simple remote.

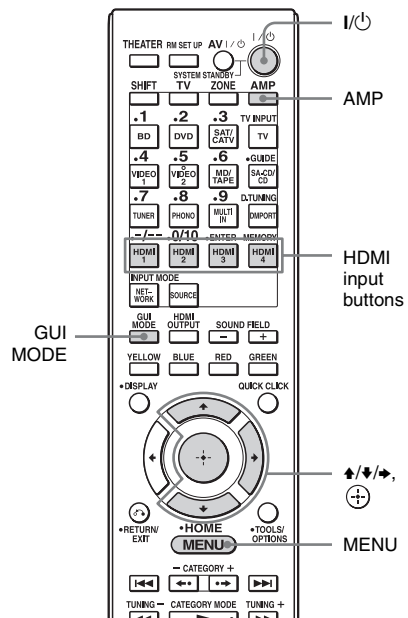

1 Press AMP.

The receiver can be operated using the remote.

2 Press MENU.

The menu is displayed on the TV screen.

3 Select “Settings” from the menu, then press \odot or \blacktriangleright .

4 Select “HDMI,” then press \odot or \blacktriangleright .

5 Select “Control for HDMI,” then press **(+)** or **➡**.

6 Select “ON,” then press **(+)**.

The Control for HDMI function of the receiver is activated.

7 Press **GUI MODE** to exit the **GUI** menu.

If the GUI menu is displayed, the Control for HDMI function of the playback components will not work properly.

8 Press one of the **HDMI** input buttons to display the image of the playback components for which you want to set the Control for HDMI function.

9 Turn the **Control for HDMI** function of the connected component on.

For details on setting the connected component, refer to its operating instructions.

10 Repeat steps 8 and 9 to set the Control for HDMI function and to display the image of all the playback components you want to use.

Notes

- When you pull out the HDMI cable or change the connection, perform the steps above.
- When you assign the component video input to the HDMI input using the Input Assign function, you cannot set “Control for HDMI” to “ON.”

Playing back components with one-touch operation (One-Touch Play)

By a simple operation (one-touch), components connected to the receiver with HDMI connections start automatically.

You can enjoy the sound/image using connected components.

When you set “Pass Through” to “ON,” sound and image can be output only from the TV while the receiver remains in standby mode.

Play back a connected component.

The receiver and TV are turned on simultaneously, and sound and image are output from the receiver and TV.

Note

Depending on the TV, the start of the content may not be output.

Enjoying the TV sound from the speakers connected to the receiver (System Audio Control)

You can enjoy the TV sound from the speakers connected to the receiver by a simple operation.

Depending on the TV settings, while you are watching the TV, the receiver turns on and switches to the “TV” function automatically. TV sound is output from the speakers connected to the receiver, and the volume of the TV is minimized simultaneously.

You can use the System Audio Control function as follows.

- The sound of the TV is output from the speakers connected to the receiver when you turn the receiver on while the sound is being output from the TV speaker.
- You can adjust the receiver’s volume when you adjust the TV volume.

You can also operate this function using the TV menu. For details, refer to the operating instructions of the TV.

Notes

- When “Control for HDMI” is set to “ON,” the “Audio Out” settings in the HDMI settings menu will set automatically depending on the System Audio Control settings.
- When you connect a TV that does not have System Audio Control function, the System Audio Control function does not work.

- If the TV is turned on before turning on the receiver, the TV sound will not be output for a moment.

Turning off the receiver with the TV (System Power-Off)

When you turn the TV off by using the power button on the TV's remote, the receiver and the connected components turn off automatically.

You can also use the multifunction remote to turn off the TV.

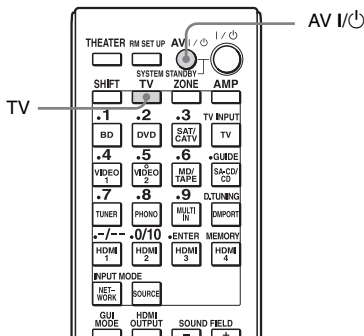

Press TV, then press AV I/O.

The TV, receiver and connected components are turned off.

Notes

- Set the TV power supply interlock function to on before using the System Power Off function. For details, refer to the operating instructions of the TV.
- Depending on the status, the connected components may not be turned off. For details, refer to the operating instructions of the connected components.

Enjoying movies with the optimum sound field (Theater Mode Sync)

Press the THEATER button on the remote of the receiver, TV, or the Blu-ray Disc Player, while pointing the remote toward the TV.

The sound field switches to HD-D.C.S. To return to the previous sound field, press the THEATER button again.

Note

The sound field may not switch depending on the TV.

Tip

The sound field may be changed back to the previous one when you change the TV's input.

Switching the monitors that output the HDMI video signals

When you have two monitors connected to the HDMI OUT A and HDMI OUT B jacks, you can switch the output for these two monitors using the HDMI OUTPUT button on the multifunction remote. This operation cannot be performed using the simple remote.

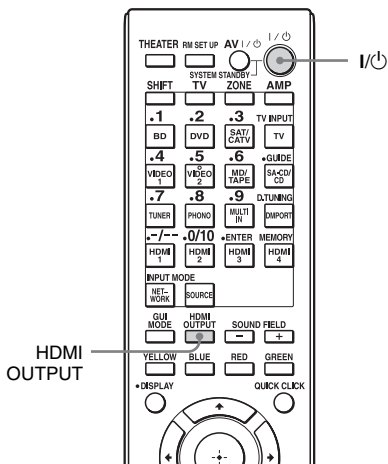

Outputting the HDMI signals even when the receiver is in standby mode

(Pass Through)

You can output the video and audio signals from the HDMI IN jack to the TV connected to the HDMI OUT A jack even when the receiver is in standby mode.

When you activate this function, make the settings for “Pass Through” following the steps below.

1 Turn on the receiver and the two monitors.

2 Press HDMI OUTPUT.

Each time you press the button, the output will be switched as follows:

HDMI A → HDMI B → HDMI A B → OFF → HDMI A...

Notes

- If the compatible video format differs between the monitors connected to the HDMI OUT A jack and the HDMI OUT B jack of the receiver, “HDMI A B” may not work.
- Depending on the playback component you connect, “HDMI A B” may not work.

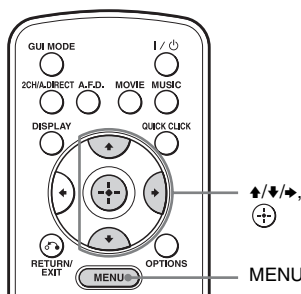

1 Select “Settings” from the menu, then press \oplus or \rightarrow .

2 Select “HDMI,” then press \oplus or \rightarrow .

3 Select “Pass Through,” then press \oplus or \rightarrow .

4 Select the parameter you want, then press \oplus or \rightarrow .

Parameter	Explanation
ON	When the receiver is in the standby mode, the receiver continuously outputs HDMI signals from the receiver’s HDMI OUT A jack.

Parameter	Explanation
OFF	The receiver does not output HDMI signals when in the standby mode. Turn on the receiver to enjoy the connected component's source on the TV. This setting saves power in the standby mode, compared with the "ON" setting.

Notes

- This function does not work when "Control for HDMI" is set to "OFF."
- This function is available only when you select "HDMI A" or "HDMI A B" using the HDMI OUTPUT button. When you select "HDMI B" or "OFF," this function does not work.

Switching between digital and analog audio

When you connect components to both digital and analog audio input jacks on the receiver, you can fix the audio input mode to either of them, or switch from one to the other, depending on the type of material you intend to watch.

In addition, the Audio Return Channel (ARC) function is available by selecting "AUTO," if TV input is selected and your TV is compatible with the Audio Return Channel (ARC) function. When using this function, you can output the TV sound to the receiver via an HDMI cable connected to the HDMI OUT A jack without connecting the TV AUDIO IN or TV OPTICAL jacks. This operation cannot be performed using the simple remote.

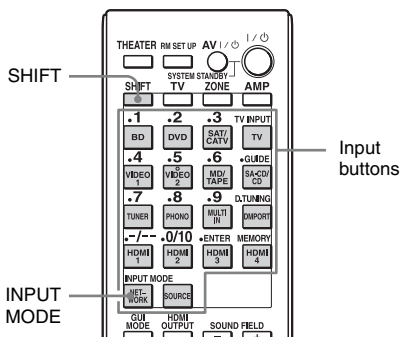

1 Select the input source using the input buttons.

2 Press **SHIFT**, then press the **INPUT MODE**.

The selected audio input mode appears in the display window.

- **AUTO**

Gives priority to digital audio signals when there are both digital and analog connections.

If there are no digital audio signals, analog audio signals are selected.

continued

When TV input is selected, priority is given to the Audio Return Channel (ARC) signals. If your TV is not compatible with the Audio Return Channel (ARC) function, the digital optical audio signals are selected.

- **OPT**

Appears only when TV input is selected, and specifies the digital optical audio signals input to the TV OPTICAL IN jack.

- **ANALOG**

Specifies the analog audio signals input to the AUDIO IN (L/R) jacks.

Notes

- Some audio input modes may not be set up depending on the input.
- When either the HDMI input, DIGITAL MEDIA PORT adapter, Server, Rhapsody, SHOUTcast, or SIRIUS is selected, “-----” appears on the display, and you cannot select other modes. Select an input other than the HDMI input, DIGITAL MEDIA PORT adapter, Server, Rhapsody, SHOUTcast, or SIRIUS then set the audio input mode.
- When “2ch Analog Direct” is being used, or the multi-channel input is selected, audio input is set to “Analog.” You cannot select other modes.
- The Audio Return Channel (ARC) function does not work in the following cases.
 - Your TV is not compatible with the Audio Return Channel (ARC) function.
 - “Control for HDMI” is set to “OFF.”
 - When you do not connect the receiver to the ARC compatible TV’s HDMI jack via an HDMI cable.

Enjoying the sound/ images from other inputs (Input Assign)

You can reassign video and/or audio signals to another input.

Example) Connect the OPTICAL OUT jack of the DVD player to the OPTICAL VIDEO 1 IN jack of this receiver when you want to input

the only digital optical audio signals from the DVD player.

Connect the component video jack of the DVD player to the COMPONENT VIDEO IN 1/ COMPONENT VIDEO IN 2, or COMPONENT VIDEO IN 3 jack of this receiver when you want to input the video signals from the DVD player. Assign video and/or audio signals to the DVD input jack using “Input Assign” in the Input menu.

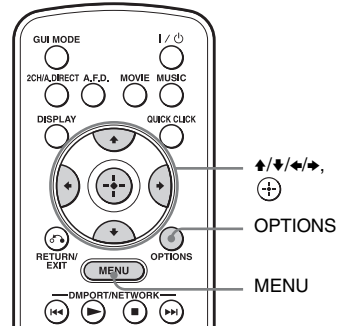

- 1 Select “Input” from the menu, then press (+) or →.**
- 2 Select the input name you want to assign.**
- 3 Press OPTIONS.**
The option menu appears.
- 4 Select “Input Assign,” then press (+).**
- 5 Select the audio and/or video signals you want to assign to the input selected in step 2, then press (+).**

Input name		BD	DVD	SAT/ CATV	VIDEO1	VIDEO2	MD/TAPE	SA-CD/ CD	MULTI IN	HDMI1	HDMI2	HDMI3	HDMI4
Assignable video input jacks	BD Composite	○	-	-	-	-	-	-	-	-	-	-	-
	DVD Composite	-	○	-	-	-	-	-	-	-	-	-	-
	SAT/CATV Composite	-	-	○	-	-	-	-	-	-	-	-	-
	VIDEO1 Composite	-	-	-	○*	-	-	-	-	-	-	-	-
	VIDEO2 Composite	-	-	-	-	○*	-	-	-	-	-	-	-
	Component1	○*	○	○	○	○	○	○	○	○**	○**	○**	○**
	Component2	○	○*	○	○	○	○	○	○	○**	○**	○**	○**
	Component3	○	○	○*	○	○	○	○	○	○**	○**	○**	○**
	HDMI1	○	○	○	○	○	○	○	○	○*	-	-	-
	HDMI2	○	○	○	○	○	○	○	○	-	○*	-	-
HDMI3	○	○	○	○	○	○	○	○	-	-	○*	-	
HDMI4	○	○	○	○	○	○	○	○	-	-	-	○*	
Assignable audio input jacks	VIDEO1 OPT	○	○	○	○*	-	-	○	-	-	-	-	-
	VIDEO2 OPT	○	○	○	-	○*	-	○	-	-	-	-	-
	MD/TAPE OPT	○	○	○	-	-	○*	○	-	-	-	-	-
	BD COAX	○*	-	○	○	○	○	-	-	-	-	-	-
	DVD COAX	-	○*	○	○	○	○	-	-	-	-	-	-
	SA-CD/CD COAX	-	-	○	○	○	○	○*	-	-	-	-	-

* Initial setting

** When you assign a component video input to the HDMI input via the Input Assign menu, component video signals are not converted to HDMI video signals and are not output from the HDMI OUT jacks. Component video signals are output from the COMPONENT VIDEO MONITOR OUT jack. In this case, the resolution of the GUI output is set to “480p” for both component video input and HDMI video input.

Notes

- You cannot assign other optical input to the inputs to which optical input jack is initially assigned, and you cannot assign other coaxial input to the inputs to which coaxial input jack is initially assigned.
- When you assign the digital audio input, the INPUT MODE setting may change automatically.
- You cannot reassign more than one HDMI input to the same input.
- You cannot reassign more than one digital audio input to the same input.
- You cannot reassign more than one component video input to the same input.
- When you assign a component video input to the HDMI input, set “Control for HDMI” to “OFF.”

Using the sleep timer

You can set the receiver to turn off automatically at a specified time. Use the multifunction remote for this operation. This operation cannot be performed using the simple remote.

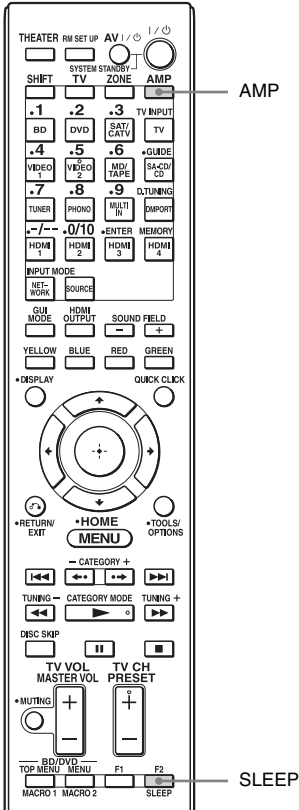

- 1 Press AMP.
- 2 Press SLEEP repeatedly.

Each time you press SLEEP, the display changes cyclically as follows:

0:30:00 → 1:00:00 → 1:30:00 → 2:00:00 → OFF

When sleep timer is being used, "SLEEP" lights up in the display window of the receiver.

Tip

To check the remaining time before the receiver turns off, press SLEEP. The remaining time appears on the display. If you press SLEEP again, the sleep timer will be changed.

Enjoying the surround effect at low volume levels (Night Mode)

This function allows you to retain a theater like environment at low volume levels. This function can be used with other sound fields. When watching a movie late at night, you will be able to hear the dialog clearly even at a low volume level.

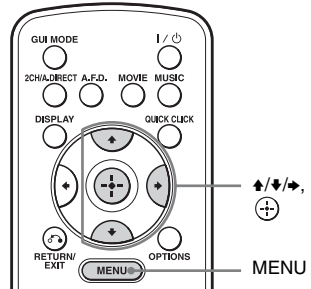

- 1 Select "Settings" from the menu, then press \oplus or \rightarrow .
- 2 Select "Audio," then press \oplus or \rightarrow .
- 3 Select "Night Mode," then press \oplus .
- 4 Select "ON," then press \oplus .

Notes

- This function does not work when the multi-channel input is selected.
- This function does not work when "2ch Analog Direct" is being used.

- This function does not work when Dolby TrueHD, or Linear PCM signals with a sampling frequency of 176.4 kHz and higher are being received.

Tip

While this function is on, the Bass, Treble increase, and “D. Range Comp” is automatically set to “MAX.”

Recording using the receiver

You can record from a video/audio component using the receiver. Refer to the operating instructions supplied with your recording component.

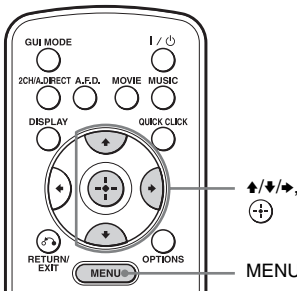

Recording with an audio component

You can record with an audio component using the receiver. Refer to the operating instructions supplied with your MD deck or tape deck.

- 1 Select “ Input” from the menu, then press or .
- 2 Select the playback component, then press .
- 3 Prepare the playback component for playing.

For example, insert a CD into the CD player.

4 Prepare the recording component.

Insert a blank MD or tape into the recording deck and adjust the recording level.

5 Start recording on the recording deck, then start playback on the playback component.

Notes

- If you use an SCMS-compliant recording deck, you may not make recordings.
- The audio input signals from the MULTI CHANNEL INPUT jacks may not be output.
- Only analog input signals are output from the analog output jack (for recording).
- Signals input from the COAXIAL IN jack or the OPTICAL IN jack are output to the OPTICAL MD/TAPE OUT jack, unless MD/Tape input is selected.
- HDMI sound cannot be recorded.

To record digital sound

Connect a component for playback to the digital audio input (OPTICAL IN) jack, and connect the recording component to the OPTICAL MD/TAPE OUT jack.

Recording with a video component

- 1 Select “ Input” from the menu, then press or .
- 2 Select the playback component, then press .
- 3 Prepare the component for playing.

For example, insert the video tape you want to copy into the VCR.

4 Prepare the recording component.

Insert a blank video tape, etc., into the recording component (VIDEO 1) for recording.

5 Start recording on the recording component, then start playback on the playback component.

Notes

- Some sources contain copy guards to prevent recording. In this case, you may not be able to record from the sources.
- Analog input signals (audio and composite video) are output from the analog output jacks.
- While only composite video signals are being recorded, the auto standby function of the receiver may start up and interrupt the recording. In this case, set "Auto Standby" to "OFF" (page 127).

Switching the command mode of the receiver and the remote

You can switch the command mode (COMMAND MODE AV 1 or COMMAND MODE AV 2) of the receiver and the remote. Switch the command mode from the initial setting to the appropriate setting, if other Sony component is operated accidentally by the same remote, when you are operating the receiver using the remote supplied with the receiver.

The command modes of both the receiver and the remote are those of the initial setting (COMMAND MODE AV 2).

The receiver and the remote, on the contrary, should use the same command mode. If the command modes of the receiver and the remote are different, you cannot use the remote to operate the receiver.

Switching the command mode of the receiver

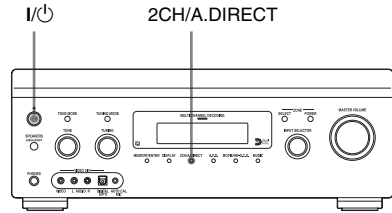

- 1 Press I/⏻ to turn off the receiver.
- 2 While holding down 2CH/A.DIRECT, press I/⏻ to turn on the receiver.

When the command mode is set to "AV2," "C. MODE AV2" appears on the display. When the command mode is set to "AV1," "C. MODE AV1" appears on the display.

Switching the command mode of the simple remote commander

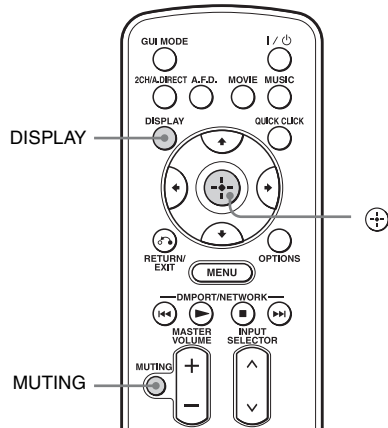

Press MUTING and  at the same time while pressing DISPLAY.

Switching the command mode of the multifunction remote commander

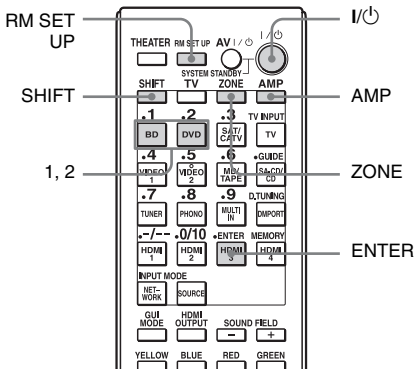

- 1 Press I/O while pressing RM SET UP.**
The AMP and ZONE buttons flash.
- 2 Press AMP.**
The ZONE button goes off, the AMP button keeps flashing and the SHIFT button lights up.
- 3 Press the numeric button 1 or 2 while the AMP button is flashing.**
When you press 1, the command mode is set to AV SYSTEM 1. When you press 2, the command mode is set to AV SYSTEM 2.
The AMP button lights up.
- 4 Press ENTER.**
The AMP button flashes twice, then the command mode setting process is completed.

Using a bi-amplifier connection

If you are not using surround back speakers and front high speakers, you can use the SURROUND BACK/FRONT HIGH/ZONE 2 terminals for the front speakers for use with a bi-amplifier connection.

To connect speakers

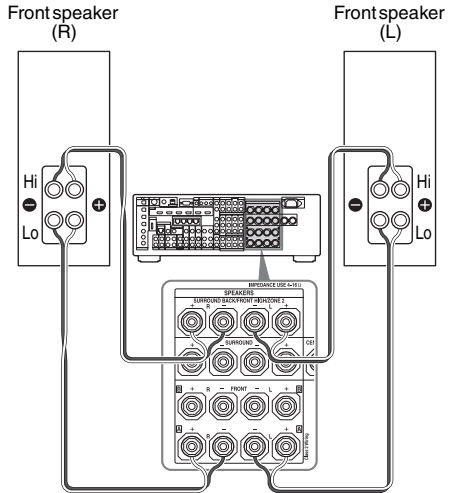





Connect the jacks on the Lo (or Hi) side of the front speakers to the FRONT **A** terminals, and connect the jacks on the Hi (or Lo) side of the front speakers to the SURROUND BACK/FRONT HIGH/ZONE 2 terminals. Make sure that metal fittings of Hi/Lo attached to the speakers have been removed from the speakers. Not doing so may cause a malfunction of the receiver.

To set up speakers

- Select "Settings" from the menu, then press **+** or **➔**.
- Select "Speaker," then press **+** or **➔**.
- Select "Speaker Pattern," then press **+**.

continued

- 4 Select the appropriate speaker pattern so that there are no surround back speakers and no front high speakers.
 - 5 Press RETURN/EXIT .
 - 6 Select “Sur Back Assign,” then press .
 - 7 Select “BI-AMP,” then press .
- The same signals output from the FRONT  terminals can be output from the SURROUND BACK/FRONT HIGH/ZONE 2 terminals.

Notes

- You cannot use the FRONT  terminals for a bi-amplifier connection.
- When you use the auto calibration function, make the bi-amplifier settings before you perform auto calibration.
- If you make the bi-amplifier settings, the speaker level, and equalizer settings of the surround back speakers become invalid, and those of the front speakers are used.
- Signals output from the PRE OUT jacks are used with the same settings as those of the SPEAKERS terminals.
- If the speaker pattern is set so that there are surround back speakers or front high speakers, you cannot make the bi-amplifier settings.

Adjusting Settings

Using the setting menu

You can adjust the various settings for speakers, surround effects, multi zone, etc., using the setting menu.

To display the menu of the receiver on the TV screen, make sure that the receiver is in “GUI MODE” by following the step in “To turn “GUI MODE” on and off” (page 55).

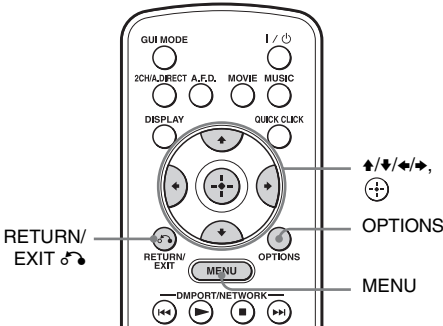

1 Press MENU.

The menu is displayed on the TV screen.

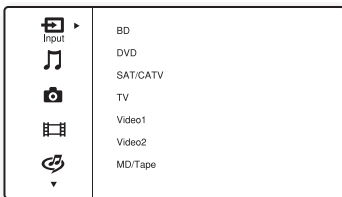

2 Select “Settings” from the menu, then press **+** or **→** to enter the menu mode.

The setting menu list appears on the TV screen.

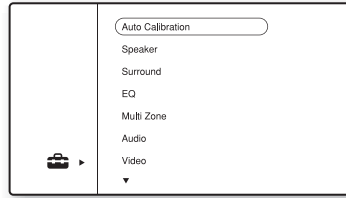

3 Select the menu item you want, then press **+** to enter.

Example: When you select “Auto Calibration”

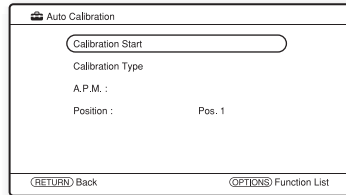

4 Select the parameter you want, then press **+** to enter.

To return to the previous screen

Press RETURN/EXIT

To exit the menu

Press MENU.

Setting menu list

Menu	Description
Auto Calibration	Sets the speaker level or distance and makes the measurement automatically (page 110).
Speaker	Sets the speaker position and impedance manually (page 112).
Surround	Adjusts the sound field (surround effect) you selected (page 116).
EQ	Adjusts the equalizer (bass/treble sound) (page 117).

Menu	Description
Multi Zone	Makes the settings for Multi Zone (page 117).
Audio	Sets various sound items (page 119).
Video	Adjusts the resolution of analog video signals (page 121).
HDMI	Makes settings for sound/ images from components connected to the HDMI jacks (page 123).
Network	Makes the settings for the network (page 124).
Quick Click	Controls components connected to the receiver using the on-screen remote (page 127).
System	Makes the settings for the system of the receiver (page 127).

Auto Calibration

Calibration Start

Performs auto calibration. For details, see “10: Calibrating the appropriate speaker settings automatically (Auto Calibration)” (page 46).

Note

The measurement results will be overwritten and saved on the currently selected position in the Position menu.

Calibration Type

Lets you select the calibration type for each seating position. For details, see “Saving the measurement results” (page 49).

Note

You can select this parameter only when you have performed auto calibration and saved the measurement result.

A.P.M.

You can set the A.P.M. (Automatic Phase Matching) function in the DCAC (Digital Cinema Auto Calibration) function (page 46).

■ OFF

Does not activate the A.P.M. function.

■ AUTO

Switches the A.P.M. function on or off automatically.

Notes

- Even when you set this item to “AUTO,” this function does not work if you select “OFF” for the calibration type (page 49).
- This function does not work in the following cases.
 - The multi-channel input is selected.
 - “2ch Analog Direct” is being used.
 - Signals with a sampling frequency of 88.2 kHz and higher are being received.

Position

You can register 3 patterns as Pos. 1, 2, and 3, depending on the listening position, listening environment, and measurement conditions.

To register settings for the listening environment

You can select the seating position you want and register the measurement results of the auto calibration for that seating position.

- 1 Select the position (Pos. 1, 2, 3) for which you want to register the measurement result, then press \oplus .
- 2 Select "Calibration Start," then press \oplus .
- 3 Press \uparrow/\downarrow repeatedly and \oplus to uncheck the items you do not want to measure, then press \rightarrow .
The confirmation screen, asking whether you are ready to start measurement, appears.
- 4 Press \rightarrow to select "Start."
The measurement results is registered as the position you selected in step 1.
- 5 Repeat step 1 to 4 to register another seating position.

To select the registered seating position

Select the position (Pos. 1, 2, 3) you want, then press \oplus .

The registered seating position is selected.

To name the Seating Position

You can rename the position name.

- 1 Select the the position (Pos. 1, 2, 3) you want, then press \oplus .
- 2 Press OPTIONS.
- 3 Select "Name Input," then press \oplus .

- 4 Press \uparrow/\downarrow to select a character, then press \rightarrow .
You can shift input position backward and forward by pressing \leftarrow/\rightarrow .
- 5 Repeat steps 4 to input a character one by one, then press \oplus .
The name you entered is registered.

Speaker settings

You can adjust each speaker manually. You can also adjust the speaker levels after auto calibration is completed.

Note

The Speaker settings are only for the current “Seating Position.”

Impedance

You can set the speaker impedance. For details, see “9: Setting the speakers” (page 43).

■ 4 ohms

■ 8 ohms

Speaker Pattern

Selects “Speaker Pattern” according to the speaker system which you are using. Select the speaker pattern before you perform auto calibration.

Sur Back Assign

Lets you set the SURROUND BACK/FRONT HIGH/ZONE 2 terminals for a bi-amplifier connection or a zone 2 connection.

■ OFF

■ BI-AMP

■ ZONE2

Note

Set “Sur Back Assign” to “OFF,” then connect the surround back speakers to this receiver when you want to change the connection from a bi-amplifier connection or a zone 2 connection to a surround back speakers connection. Re-set up the speakers after you connect the surround back speakers. See “Auto Calibration” (page 46) or “Manual Setup.”

Manual Setup

You can adjust each speaker manually on the Manual Setup screen. You can also adjust the speaker levels after auto calibration is completed.

To adjust the speaker level

You can adjust each speaker’s level (center, surround left/right, surround back left/right, front high left/right, subwoofer).

- 1 Select the speaker on the screen for which you want to adjust the level, then press \oplus .
- 2 Select “Level:.”
- 3 Set the level of the selected speaker, then press \oplus .

You can adjust the level from -20 dB to $+10$ dB in 0.5 dB steps.

For the front left/right speakers, you can adjust the balance on either side. You can adjust the front left level from $FL-10.0$ dB to $FL+10.0$ dB in 0.5 dB steps. You can also adjust the front right level from $FR-10.0$ dB to $FR+10.0$ dB in 0.5 dB steps.

Note

When one of the sound fields for music is selected, no sound is output from the subwoofer if all the speakers are set to “Large.” However, the sound will be output from the subwoofer if the digital input signal contains L.F.E. signals, or if the front or surround speakers are set to “Small,” the sound field for movie is selected, or “Portable Audio” is selected.

To adjust the distance from the seating position to each speaker

You can adjust the distance from the seating position to each speaker (front left/right, center, surround left/right, surround back left/right, front high left/right, subwoofer.)

1 Select the speaker on the screen for which you want to adjust the distance from the seating position, then press .

2 Select a “Distance:.”

3 Set the distance of the selected speaker, then press .

You can adjust the distance from 1.0 meter to 10.0 meters (3 feet 3 inches to 32 feet 9 inches) in 1 cm (1 inch) steps.

To adjust the size of each speaker

You can adjust each speaker’s (front left/right, center, surround left/right, surround back left/right, front high left/right) size.

1 Select the speaker on the screen for which you want to adjust the size, then press .

2 Select a “Size:.”

3 Set the size of the selected speaker, then press .

- Large

If you connect large speakers that will effectively reproduce bass frequencies, select “Large.” Normally, select “Large.”

- Small

If the sound is distorted, or you feel a lack of surround effects when using multi-channel surround sound, select “Small” to activate the bass redirection circuitry and output the bass frequencies of each channel from the subwoofer or other “Large” speakers.

Tips

- The “Large” and “Small” settings for each speaker determine whether the internal sound processor will cut the bass signal from that channel. When the bass is cut from a channel, the bass redirection circuitry sends the corresponding bass frequencies to the subwoofer or other “Large” speakers. However, since bass sound has a certain amount of directionality, it is best not to cut it, if possible. Therefore, even when using small speakers, you can set them to “Large” if you want to output the bass frequencies from that speaker. On the other hand, if you are using a large speaker, but prefer not to have bass frequencies output from that speaker, set it to “Small.” If the overall sound level is lower than you prefer, set all speakers to “Large.” If there is not enough bass, you can use the equalizer to boost the bass levels.
- The surround back will be set to the same setting as that of the surround speakers.
- When the front speakers are set to “Small,” the center, surround, surround back, and front high speakers are also automatically set to “Small.”
- If you do not use the subwoofer, the front speakers are automatically set to “Large.”

Crossover Freq (Speaker crossover frequency)

Lets you set the bass crossover frequency of speakers that has been set to “Small” in the Speaker menu. Measured speaker crossover frequency is set for each speaker after auto calibration.

1 Select the speaker on the screen you want to adjust, then press .

2 Adjust the value, then press .

Test Tone

You can select the test tone type on the Test Tone screen.

Tips

- To adjust the level of all speakers at the same time, press MASTER VOLUME +/-.
- The adjusted value is shown on the display during adjustment.

To output a test tone from each speaker

You can output a test tone from the speakers in sequence.

- 1 Select “Test Tone,” then press \oplus .
The Test Tone screen appears.
- 2 Adjust the parameter, then press \oplus .
 - OFF
 - AUTO
The test tone is output from each speaker in sequence.
 - L, C, R, SR, SB*, SBR, SBL, SL, LH, RH, SW
* “SB” appears when only one surround back speaker is connected.You can select which speakers will output the test tone.

- 3 Adjust “Level:,” then press \oplus .

To output a test tone from adjacent speakers

You can output a test tone from adjacent speakers so that you can adjust the balance between the speakers.

- 1 Select “Phase Noise,” then press \oplus .
The Phase Noise screen appears.
- 2 Adjust the parameter, then press \oplus .
 - OFF
 - L/C, C/R, R/SL, R/SR, SR/SL, SR/SBR, SR/SB*, SBR/SBL, SB/SL*, SBL/SL, SL/L, L/SR, L/RH, LH/RH, LH/R
* “SR/SB” and “SB/SL” appear when only one surround back speaker is connected.

Lets you output the test tone sequentially from adjacent speakers.

Some items may not be displayed, depending on the setting of the speaker pattern.

- 3 Adjust “Level:,” then press \oplus .

To output the source sound from adjacent speakers

You can output the source sound from adjacent speakers so that you can adjust the balance between the speakers.

- 1 Select “Phase Audio,” then press \oplus .
The Phase Audio screen appears.
- 2 Adjust the parameter, then press \oplus .
 - OFF
 - L/C, C/R, R/SL, R/SR, SR/SL, SR/SBR, SR/SB*, SBR/SBL, SB/SL*, SBL/SL, SL/L, L/SR, L/RH, LH/RH, LH/R
* “SR/SB” and “SB/SL” appear when only one surround back speaker is connected.Lets you output front 2 channel source sound (instead of the test tone) sequentially from adjacent speakers. Some items may not be displayed, depending on the setting of the speaker pattern.

- 3 Adjust “Level:,” then press \oplus .

Note

When Dolby TrueHD, or Linear PCM signals with a sampling frequency of 176.4 kHz and higher are being received, sound is output only from the front left/right speakers.

When a test tone is not output from the speakers

- The speaker cords may not be connected securely. Check to see if they are connected securely and cannot be disconnected by pulling on them slightly.
- The speaker cords may have the short-circuit problem.

When a test tone is output from a different speaker than the speaker displayed on the screen

The speaker pattern to the connected speaker is not set up correctly. Make sure the speaker connection and the speaker pattern match.

D. Range Comp (Dynamic range compressor)

Lets you compress the dynamic range of the soundtrack. This may be useful when you want to watch movies at low volumes late at night. Dynamic range compression is possible with Dolby Digital sources only.

■ OFF

The dynamic range is not compressed.

■ AUTO

The dynamic range is compressed automatically.

■ STD

The dynamic range is compressed as intended by the recording engineer.

■ MAX

The dynamic range is compressed dramatically.

Tips

- Dynamic range compressor lets you compress the dynamic range of the soundtrack based on the dynamic range information included in the Dolby Digital signal.
- “STD” is the standard setting, but it only enacts light compression. Therefore, we recommend using the “MAX” setting. This greatly compresses the dynamic range and lets you view movies late at night at low volumes. Unlike analog limiters, the levels are predetermined and provide a very natural compression.

Distance Unit (Distance unit)

Lets you select the unit of measure for setting distances.

■ meter

The distance is displayed in meters.

■ feet

The distance is displayed in feet.

Surround settings

You can select the sound field and adjust the effect level, etc., on the Sound Field Select screen.

For details on the sound field, see “Enjoying Surround Sound” (page 72).

Note

The setup items you can adjust on each menu vary depending on the sound field.

To select the sound field

- 1 Select the Sound Field you want.
- 2 Press RETURN/EXIT ↵.

To select the effect type for HD-D.C.S.

- 1 Select “HD-D.C.S.,” then press ⊕ or ➔.

- 2 Select the effect type you want, then press ⬅.

HD-D.C.S. has three different types:

Theater, Dynamic, and Studio. Each type has different reflection and reverberation sound mixture levels and is optimized to match a listener’s room uniqueness, taste and mood.

- Theater

Theater type (default setting) mixes reflection and reverberation sound creating the characteristics of a mastering studio. Additionally, this type mixes in frequency characteristics that are often found in professional studios and movie theaters. It is ideal for watching movies in a listening room that has less reverberation.

- Dynamic

Want to enjoy the sound effects to the full extent, just like at the movie theaters?

Dynamic type emphasizes on the reflection sound. Without HD-D.C.S., many rooms are often somewhat reverberant but lack a spacious feeling.

This type acoustically opens up those types of rooms and provides a spacious and dynamism feeling equivalent to a mastering studio.

- Studio

In Studio type, effects are kept to a minimum, while still providing a great theater experience. This type provides the accuracy of the original recording.

- 3 Press RETURN/EXIT ↵.

To adjust the gain level of the front height channels

You can adjust the gain level of the front height channels for Pro Logic IIz mode.

- 1 Select “PLIIz Height,” then press ⊕ or ➔.

- 2 Adjust the gain level, then press ⬅.

- Low

Decreases the gain level to ±0 dB.

- Mid

Increases the gain level to +3 dB (default setting).

- High

Increases the gain level to +5 dB.

- 3 Press RETURN/EXIT ↵.

EQ settings

You can use following parameters to adjust the tonal quality (bass/treble level) of front, center and surround/surround back speakers.

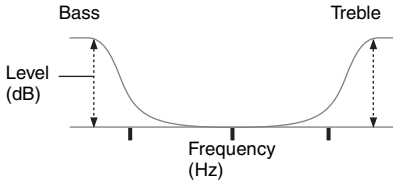

Note

- This function does not work in the following cases.
 - The multi-channel input is selected.
 - “2ch Analog Direct” is being used.
 - Dolby TrueHD, or Linear PCM signals with a sampling frequency of 176.4 kHz and higher are being received.

To adjust the equalizer on the EQ screen

- 1 Select the speaker on the screen you want to adjust, then press \oplus .
- 2 Select “Bass” or “Treble.”
- 3 Adjust the gain, then press \oplus .

Multi Zone settings

You can make settings for the main zone, zone 2 or zone 3.

Multi Zone Setup

To turn the power on or off for zone 2/zone 3

You can turn zone 2 or zone 3 operation on or off. “Main” (this receiver) is always selected. You cannot turn it off.

- 1 Select the zone you want to turn on or off, then press \oplus .
- 2 Select “ON” or “OFF,” then press \oplus .

■ ON

■ OFF

To select the output source for each zone

You can select the source that is output to the zone. Audio and video signals are output to zone 2, while only audio signals are output to zone 3.

- 1 Select the zone to which you want to output audio/video signals, then press \oplus .
- 2 Select “Input,” then press \oplus .
- 3 Select the input, then press \oplus .

To adjust the volume for zone 2

You can adjust the volume in the main zone. If “Sur Back Assign” is set to “ZONE2” in the Speaker settings menu, you can also adjust the volume of zone 2.

If you set “Zone2 Line Out Level” to “VARIABLE,” you can also adjust the volume using “Multi Zone Setup.”

- 1 Select the zone for which you want to adjust the volume, then press \oplus .
- 2 Select "Volume," then press \oplus .
- 3 Adjust the volume, then press \oplus .

To preset the volume for main zone/zone 2

You can preset the volume of turning the power on for each zone.

- 1 Select the zone for which you want to preset the volume, then press \oplus .
- 2 Select "Preset Volume," then press \oplus .
- 3 Adjust the volume, then press \oplus .
During the adjustment, the sound is output at the volume level to which you have adjusted it, regardless of the value of MASTER VOLUME control.
If you select "OFF," each zone is activated at the same volume as that in effect when you turned the power off last time.

Note

- You cannot preset the volume for zone 2 in the following cases.
 - "Sur Back Assign" is set to "OFF" or "BI-AMP."
 - "Zone2 Line Out Level" is set to "FIXED."

Zone2 Line Out Level

Lets you set the volume control for the ZONE 2 AUDIO OUT jacks to "VARIABLE" or "FIXED." For details, see "Set the volume control for zone 2" (page 94)

■ VARIABLE

■ FIXED

12V Trigger

You can turn the receiver on or off in another zone, or select various options for use of the 12V Trigger function.

■ OFF

Lets you turn off output of 12V triggers even when the main receiver is turned on.

■ Ctrl

Lets you turn the output of 12V triggers on or off manually using the control command of an external control device.

■ Zone

Lets you turn the output of 12V triggers on or off based on whether the selected zone is turned on or off.

■ Input

Lets you turn on the output of 12V triggers when the preset input is selected.
When you select "Input," the setting display which sets each input trigger to on/off appears. Press $\blacktriangle/\blacktriangledown$ to select the input, then press \oplus to check the box.

■ HDMI-A

Lets you turn the output of 12V triggers on or off based on the output setting of the HDMI OUT A jack.

■ HDMI-B

Lets you turn the output of 12V triggers on or off based on the output setting of the HDMI OUT B jack.

Tip

Even when this receiver is standby mode (press I/⏻ on the remote to turned off this receiver), the receiver in zone 2 or zone 3 remains turned on. To turn off all receivers, press I/⏻ and AV I/⏻ on the multifunction remote at the same time (SYSTEM STANDBY).

Audio settings

You can make settings for the audio to suit your preference.

Digital Legato Linear (D.L.L.)

The D.L.L. function is Sony proprietary technology that allows low quality digital audio signals and analog audio signals to be played back with high quality sound.

■ OFF

■ AUTO 1

This function is available for lossy compression audio formats and analog audio signals.

■ AUTO 2

This function is available for Linear PCM signals, as well as lossy compression audio formats and analog audio signals.

Note

- This function works when “A.F.D. Auto” is selected. However, this function does not work in the following cases.
 - Linear PCM signals with a sampling frequency of other than 44.1 kHz are being received.
 - Dolby Digital Plus, Dolby Digital EX, Dolby TrueHD, DTS 96/24, DTS-ES Matrix 6.1, DTS-HD Master Audio, or DTS-HD High Resolution Audio signals are being received.

A/V Sync (Synchronizes audio and video output)

Lets you delay the output of audio to minimize the time gap between audio output and visual display.

■ 0 ms – 300 ms

You can adjust the delay from 0 ms to 300 ms in 10 ms steps.

Notes

- This function is useful when you use a large LCD or plasma monitor or a projector.
- This function does not work in the following cases.
 - The multi-channel input is selected.
 - “2ch Analog Direct” is being used.

Dual Mono (Digital broadcast language selection)

Lets you select the language you want when you listen to the dual audio of a digital broadcast. This feature only functions for Dolby Digital sources.

■ MAIN/SUB

Sound of the main language will be output through the front left speaker, and sound of the sub language will be output through the front right speaker simultaneously.

■ MAIN

Sound of the main language will be output.

■ SUB

Sound of the sub language will be output.

Decode Priority (Digital audio input decoding priority)

Lets you specify the input mode for the digital signal input to the DIGITAL IN jacks or HDMI IN jacks.

■ PCM

When signals from the DIGITAL IN jack are selected, PCM signals are given priority (to prevent interruption when playback starts). However, when other signals are input, there may be no sound, depending on the format. In this case, set this item to “AUTO.”
When signals from the HDMI IN jack are selected, only PCM signals are output from the connected player. When signals in any other format are received, set this item to “AUTO.”

■ AUTO

Automatically switches the input mode between Dolby Digital, DTS, or PCM.

Notes

- Even when “Decode Priority” is set to “PCM,” the sound may be interrupted at the very beginning of the first track due to signals on the CD being played back.
- When you play back a DTS CD, set “Decode Priority” to “AUTO” to prevent noise being output.

Night Mode

Lets you to retain a theater-like environment at low volume levels. This function can be used with other sound fields. When watching a movie late at night, you will be able to hear the dialog clearly even at a low volume level.

■ ON

■ OFF

Video settings

Makes settings for video.

Resolution (Converting video signals)

Lets you convert the resolution of analog video input signals.

■ 480i/576i

■ 480p/576p

■ DIRECT

Lets you output analog video input signals without conversion.

■ 720p

■ 1080i

■ AUTO

■ 1080p

"Resolution" menu setting	Output from		HDMI OUT jacks	MONITOR COMPONENT VIDEO OUT jacks	MONITOR VIDEO OUT jack
	Input from				
DIRECT	COMPONENT VIDEO IN jacks		–	○	–
	VIDEO IN jacks		–	–	○
AUTO (initial setting)	COMPONENT VIDEO IN jacks		● ^{a)}	● ^{b)}	● ^{b)}
	VIDEO IN jacks			● ^{b)}	● ^{b)}
480i/576i	COMPONENT VIDEO IN jacks		● ^{c)}	●	●
	VIDEO IN jacks		● ^{c)}	●	●
480p/576p	COMPONENT VIDEO IN jacks		●	●	–
	VIDEO IN jacks		●	●	○
720p, 1080i	COMPONENT VIDEO IN jacks		●	● ^{d)}	–
	VIDEO IN jacks		●	● ^{d)}	○
1080p	COMPONENT VIDEO IN jacks		●	○	–
	VIDEO IN jacks		●	–	○

● : Video signals are converted and output through the video converter.

○ : The same type of signal as that of the input signal is output. Video signals are not converted.

– : Video signals are not output.

^{a)}The resolution is set automatically, depending on the connected monitor.

^{b)}When the TV is connected to jacks other than the HDMI jacks, 480i/576i signals are output when "Resolution" is set to "AUTO."

^{c)}480p/576p signals are output even if 480i/576i is set.

^{d)}Video signals without copyright protection are output based on the settings menu. Video signals with copyright protection are output as 480p.

continued

Notes

• Video signals are not output from the COMPONENT VIDEO MONITOR OUT or MONITOR VIDEO OUT jacks when the monitor, etc., is connected to HDMI OUT jacks.

- If you select a resolution that the connected TV does not support in the “Resolution” menu, the images from the TV cannot be output correctly.
- Converted HDMI image output does not support x.v.Color (x.v.Colour), Deep Color (Deep Colour) and 3D.

Zone2 Resolution

Lets you convert the resolution of analog video input signals in zone 2.

■ 720p

■ 1080i

■ 480i/576i

■ 480p/576p

“Zone2 Resolution” menu setting	Output from		ZONE 2 COMPONENT VIDEO OUT jacks	ZONE 2 VIDEO OUT jack
	Input from			
480i/576i (initial setting)	COMPONENT VIDEO IN jacks		●	●
	VIDEO IN jacks		●	●
480p/576p	COMPONENT VIDEO IN jacks		●	–
	VIDEO IN jacks		●	–
720p, 1080i	COMPONENT VIDEO IN jacks		●*	–
	VIDEO IN jacks		●*	–

● : Video signals are converted and output through the video converter.

– : Video signals are not output.

* Video signals without copyright protection are output based on the settings menu. Video signals with copyright protection are output as 480p. This receiver do not support 1080p input signals for zone. You cannot up-convert the video signals to 1080p using this receiver.

HDMI settings

Makes the required settings for components connected to the HDMI jacks.

Control for HDMI

Lets you turn the function which controls components connected to the HDMI jack using an HDMI cable on or off.

■ OFF

■ ON

Note

When “Control for HDMI” is set to “ON,” “Audio Out” may be changed automatically.

Pass Through

Lets you output the HDMI signals to the TV even when the receiver is in standby mode. For details, see “Outputting the HDMI signals even when the receiver is in standby mode (Pass Through)” (page 100).

■ OFF

■ ON

Note

When “Control for HDMI” is set to “OFF,” you cannot set “Pass Through.”

Audio Out

Lets you set the HDMI audio signals output from the playback component connected to the receiver via an HDMI connection.

■ TV+AMP

The sound is output from the TV speaker and the speakers connected to the receiver.

Notes

- The sound quality of the playback component depends on the TV’s sound quality, such as the number of channels, and the sampling frequency, etc. When the TV has stereo speakers, the sound output from the receiver is also stereo as that of the TV, even if you play multi-channel source.
- When you connect the receiver to a video component (projector, etc.), sound may not be output from the receiver. In this case, select “AMP.”
- When you select the input that you have assigned the HDMI input, sound is not output from the TV.

■ AMP

The HDMI audio signals from the playback component is only output to speakers connected to the receiver. The multi-channel sound can be played back as it is.

Note

Audio signals are not output from the TV speaker when “Audio Out” is set to “AMP.”

Subwoofer Level

Lets you set the level of the subwoofer to 0 dB or +10 dB when PCM signals are input via an HDMI connection. You can set the level for each HDMI input independently.

■ 0 dB

■ AUTO

Automatically sets the level to 0 dB or +10 dB depending on the audio stream.

■ +10 dB

Subwoofer LPF

Lets you turn the low-pass filter for the subwoofer output on or off. The low-pass filter works when PCM signals are input via an HDMI connection. Turn the function on if you connect a subwoofer without the crossover frequency function.

■ OFF

Does not activate the low-pass filter.

■ ON

Always activates the low-pass filter with a cutoff frequency of 120 Hz.

Video Direct

Lets you output the video input signals from the HDMI IN jack directly to the HDMI OUT jack.

■ OFF

The input signals from the HDMI IN jack are output through a video processor.

■ ON

The input signals from the HDMI IN jack are output directly.

Note

Set “Video Direct” to “ON” to receive Adobe_{RGB} or Adobe_{YCC601} signals.



Network settings

Makes the settings for the network.





Network Setup

Lets you make the network settings.





To check the network settings

- 1 Select “Network Setup,” then press .
- 2 Select “Network Information,” then press .
The network setting information of the receiver is displayed on the TV screen.

To configure network settings automatically

- 1 Select “Network Setup,” then press .
- 2 Select “Internet Setup,” then press .
- 3 Select “Connect Automatically (DHCP),” then press .
“Success! The receiver is now connected to network.” appears on the TV screen.
- 4 Press  to select “Finish.”

To set the IP address manually

- 1 Select “Network Setup,” then press .
- 2 Select “Internet Setup,” then press .
- 3 Select “Manual Configuration,” then press .
The setting screen for the IP address appears on the TV screen.
- 4 Select the IP address, then press .
The soft keyboard appears on the TV screen.

- 5 Press **▲/▼/◀/▶** and **⊕** to select a character one by one to enter the IP address.
- 6 Select “Finish,” then press **⊕**.
- 7 Press **▶** to display the next screen.
- 8 Repeat the process in steps 4 to 7 again to enter the Subnet Mask, Gateway address, DNS1 address, and DNS2 address.
- 9 Select “Test Connection,” then press **⊕**.
“Success! The receiver is now connected to network.” appears on the TV screen.
- 10 Press **⊕** to select “Finish.”

To set the Proxy server manually

- 1 Select “Network Setup” then press **⊕**.
- 2 Select “Proxy Setup,” then press **⊕**.
- 3 Select “Enable,” then press **⊕**.
- 4 Press **⊕**.
The soft keyboard appears on the TV screen.
- 5 Press **▲/▼/◀/▶** and **⊕** to select a character one by one to enter the proxy server address.
- 6 Select “Finish,” then press **⊕**.
- 7 Press **▶** to select the Port number box, then press **⊕**.
The soft keyboard appears on the TV screen.
- 8 Press **▲/▼/◀/▶** and **⊕** to select a character one by one to enter the port number.
- 9 Select “Finish,” then press **⊕**.
- 10 Press **▶**.
- 11 Select “Finish,” then press **⊕**.

External Control

Let you turn the function which controls the receiver from external controllers on the home network on or off.

■ OFF

■ ON

Note

If you set “Controllers,” set “External Control” to “ON.”

Controllers

Lets you set availability of operations allowed for the receiver for network controllers on the home network that have attempted to access the receiver in the past.

1 Select “Controllers,” then press **⊕**.

The setting screen used for Controllers appears on the TV screen.

2 Select the controller you want to allow to operate the receiver from the list, then press **⊕** to check the box.

When you check the box for “Auto Permission,” all the controllers detected are checked automatically.

3 Select “Finish,” then press **⊕**.

To cancel the setup

Select “Cancel,” then press **⊕** in step 3.

To remove the detected controllers from the list

- 1 Select the controller you want to remove from the list, then press **⊕** to check the box.
- 2 Select “Remove All,” then press **⊕**.





Tip

Up to 10 network controllers that have attempted to access the receiver are listed, and each of them can control the receiver.

Device Name

Lets you assign a device name to the receiver up to 20 characters displayed as being on the home network.

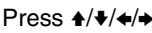
To assign the device name

- 1 Select "Device Name," then press .
- 2 Press .
The soft keyboard appears on the TV screen.
- 3 Press  and  to select a character one by one to enter the device name.
- 4 Select "Finish," then press .
When the setting is applied to the receiver, the receiver will restart automatically.

Tip

The default device name is "STR-DA4600ES."

Rhapsody Account

Lets you enter the Rhapsody Account to listen to the Rhapsody Internet radio service. For details, see "Setting an account" (page 84). Rhapsody is only available in the US.

Network Standby

Lets you turn the function that activates the switching hubs on the rear of the receiver and allows external control devices to control the receiver on or off even when the receiver is in standby mode.

■ OFF

The network function turns off when the receiver is in standby mode.

■ ON

The network function works even when the receiver is in standby mode.

In addition, the start-up time of the network function is reduced after the receiver is turned on.

Quick Click settings

You can make settings to control components connected to the receiver using the on-screen remote.

See “Operating Each Component Using the On-screen Remote (Quick Click)” (page 136) for details on using the on-screen remote.

Source Component

Selects the source component that is to be operated.

■ Preset Mode

Customizes the remote to match the source components connected to your receiver.

■ Learn Mode

Allows the remote learn codes.

■ Reset

Resets both programmed codes and learned codes.

Common Component

Selects the common component such as a TV, projector or lights that is to be operated.

■ Preset Mode

Customizes the remote to match the common components such as the TV, the projector and the lightings connected to your receiver.

■ Learn Mode

Allows the remote to learn codes.

■ Reset

Resets both programmed codes and learned codes.

Macro

Sets several commands in a sequential order as a single command.

System settings

Customizes the settings of the receiver.

RS232C Control

Lets you turn the control mode for maintenance and service on or off.

■ OFF

■ ON

Auto Standby

Lets you turn the function that switches the main zone to standby mode automatically when you do not operate the receiver or when there is no signal input to the receiver on or off.

■ ON

Switches to standby mode after approximately 30 minutes.

■ OFF

Does not switch to standby mode.

Note

This function does not work when “Server,” “Rhapsody,” “SHOUTcast,” “FM,” “AM,” “SIRIUS,” or the multi-channel input is selected.

Settings Lock

Lets you lock the settings of the receiver.

■ ON

You can only turn this function on using the setting menu. When you turn this function off, perform the following procedure.

SPEAKERS (A/B/A+B/OFF)

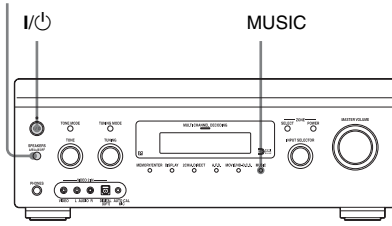





- 1 Press I/⏻ to turn off the receiver.**
- 2 While holding down MUSIC and SPEAKERS (A/B/A+B/OFF), press I/⏻ to turn on the receiver.**

Software Version

You can check the version of the software on the system of the receiver, and you can also update the software of the receiver.

You can also update the software of the receiver using the Setup Manager application software provided on the CD-ROM supplied with the receiver. For details, see “Updating the receiver software using the Setup Manager” (page 89).

To update the receiver using the menu

- 1 Select “Software Version,” then press .**
The current software version is displayed on the TV screen.
- 2 Select “Update via Internet,” then press .**
The current software version and latest software version are displayed on the TV screen.
- 3 Press  to select “Update.”**
A confirmation screen appears on the TV screen.
- 4 Select “Start,” then press .**

Receiver updating starts.

The MULTI CHANNEL DECODING lamp on the front panel flashes while updating.

When the updating complete, the receiver will restart automatically.

Notes

- In the following cases, a message appears on the TV screen and the update of the receiver is not performed.
 - When all versions are the latest one.
 - When the receiver cannot retrieve the data, such as when the network has not been set up, or when the server is down, etc.
- Do not turn the receiver off or disconnect the network cable during software updating. It may cause a malfunction.
- It may take 50 minutes for the software updating to complete.

Operating without connecting to a TV

You can operate the receiver using the display window of the receiver even if the TV is not connected to the receiver.

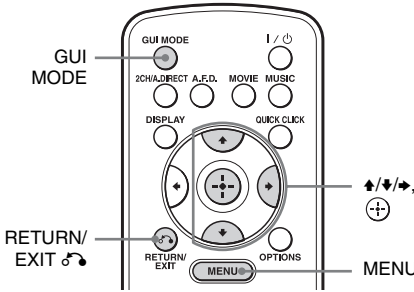

Using the menu in the display window

If “GUI MODE” is displayed in the display window of the receiver when you press MENU, DISPLAY, or \uparrow/\downarrow , press GUI MODE to switch the display mode of the menu to “DISPLAY MODE.” (After “GUI OFF” has appeared in the display window of the receiver, the receiver is switched to “DISPLAY MODE.”)

1 Turn on the receiver.

2 Press MENU.

The menu is displayed in the display window of the receiver.

Example: When you select “Speaker Settings”



3 Press \uparrow/\downarrow repeatedly to select the menu, then press \leftarrow or \rightarrow .

4 Press \uparrow/\downarrow repeatedly to select the menu item, then press \oplus .

The parameter appears in brackets.



5 Press \uparrow/\downarrow repeatedly to select the parameter you want, then press \oplus .

The parameter is entered and the brackets disappear from the display.



Tip

To return to the previous step, press RETURN/EXIT .

Menu list (in the display window)

The following options are available in each menu.

“■■■...” in the table signifies the parameter for each item.

Menu	Item	Parameter	Initial setting
Auto Calibration <AUTO CAL>	A.CAL START (Auto Calibration Start)		
		5 4 3 2 1	
		TONE	
		T.S.P.	
		WOOFER	
	COMPLETE	RETRY, SAVE EXIT, WRN CHECK, PHASE INFO, DIST. INFO, LEVEL INFO, EXIT	SAVE EXIT
	W-■■■■:4Y (Warnig code)	FL, FR, CNT, SL, SR, SBR, SBL, SW, LH, RH : 0, 1, 2, 3, 4	
	NO WARN (No Warning)		
	■■■: ■■■ (Phase Information)	FL, FR, CNT, SL, SR, SBR, SBL, SW, LH, RH : OUT, IN	
	■■■: ■■■ (Distance Information)	FL, FR, CNT, SL, SR, SBR, SBL, SW, LH, RH	
■■■: ■■■■ (Level Information)	FL, FR, CNT, SL, SR, SBR, SBL, SW LH, RH		
E-■■■:3Y (Error code)	F, SR, SB : 0, 1, 2, 3, 4		
	RETRY? ■■■	YES, NO	YES
	CANCEL		
	CAL TYPE (Calibration Type)	FULL FLAT, ENGINEER, FRONT REF, OFF	FULL FLAT
	A.P.M.	A.P.M. AUTO, A.P.M. OFF	A.P.M. AUTO
	POSITION	POS.1, POS.2, POS.3	POS.1
	NAME IN (Naming Input)	For reference on this function, see “To name the Seating Position” (page 111).	

Menu	Item	Parameter	Initial setting
Level settings <LEVEL>	TEST TONE	OFF, FL to RH (AUTO), FL to RH (FIX)	OFF
	P. NOISE (Phase noise)	OFF, FL/CNT, CNT/FR, FR/SL, FR/SR, SR/SL, SR/SBR, SR/SB, SBR/SBL, SB/SL, SBL/SL, SL/FL, FL/SR, FL/RH, LH/RH, LH/FR	OFF
	P. AUDIO (Phase audio)	OFF, FL/CNT, CNT/FR, FR/SL, FR/SR, SR/SL, SR/SBR, SR/SB, SBR/SBL, SB/SL, SBL/SL, SL/FL, FL/SR, FL/RH, LH/RH, LH/FR	OFF
	FL LEVEL (Front left speaker level)	FL-10.0 dB to FL+10.0 dB (0.5 dB step)	FL0 dB
	FR LEVEL (Front right speaker level)	FR-10.0 dB to FR+10.0 dB (0.5 dB step)	FR0 dB
	CNT LEVEL (Center speaker level)	CNT-20.0 dB to CNT+10.0 dB (0.5 dB step)	CNT0 dB
	SL LEVEL (Surround left speaker level)	SL-20.0 dB to SL+10.0 dB (0.5 dB step)	SL0 dB
	SR LEVEL (Surround right speaker level)	SR-20.0 dB to SR+10.0 dB (0.5 dB step)	SR0 dB
	SB LEVEL (Surround back speaker level)	SB-20.0 dB to SB+10.0 dB (0.5 dB step)	SB0 dB
	SBL LEVEL (Surround back left speaker level)	SBL-20.0 dB to SBL+10.0 dB (0.5 dB step)	SBL0 dB
	SBR LEVEL (Surround back right speaker level)	SBR-20.0 dB to SBR+10.0 dB (0.5 dB step)	SBR0 dB
	LH LEVEL (Left high speaker level)	LH-20.0 dB to LH+10.0 dB (0.5 dB step)	LH0 dB
	RH LEVEL (Right high speaker level)	RH-20.0 dB to RH+10.0 dB (0.5 dB step)	RH0 dB
	SW LEVEL (Subwoofer speaker level)	SW-20.0 dB to SW+10.0 dB (0.5 dB step)	SW0 dB
	D. RANGE (Dynamic range compressor)	COMP. MAX, COMP. STD, COMP. AUTO, COMP. OFF	COMP. AUTO

Menu	Item	Parameter	Initial setting
Speaker settings <SPEAKER>	SP PATTERN (Speaker pattern)	5/2.1 to 2/0 (20 patterns)	3/4.1
	FRT SIZE (Front speakers size)	LARGE, SMALL	LARGE
	CNT SIZE (Center speaker size)	LARGE, SMALL	LARGE
	SUR SIZE (Surround speakers size)	LARGE, SMALL	LARGE
	FH SIZE (Front high speakers size)	LARGE, SMALL	LARGE
	SB ASSIGN (Surround Back Speaker Assign)	OFF, BI-AMP, ZONE2	OFF
	FL DIST. (Front left speaker distance)	FL 3' 3" to FL 32' 9" (1 inch step) FL 1.0 to FL 10.0 (m) (1 cm step)	FL 9' 10" FL 3 m
	FR DIST. (Front right speaker distance)	FR 3' 3" to FR 32' 9" (1 inch step) FR 1.0 to FR 10.0 (m) (1 cm step)	FR 9' 10" FR 3 m
	CNT DIST. (Center speaker distance)	CNT 3' 3" to CNT 32' 9" (1 inch step) CNT 1.0 to CNT 10.0 (m) (1 cm step)	CNT 9' 10" CNT 3 m
	SL DIST. (Surround left speaker distance)	SL 3' 3" to SL 32' 9" (1 inch step) SL 1.0 to SL 10.0 (m) (1 cm step)	SL 9' 10" SL 3 m
	SR DIST. (Surround right speaker distance)	SR 3' 3" to SR 32' 9" (1 inch step) SR 1.0 to SR 10.0 (m) (1 cm step)	SR 9' 10" SR 3 m
	SB DIST. (Surround back speaker distance)	SB 3' 3" to SB 32' 9" (1 inch step) SB 1.0 to SB 10.0 (m) (1 cm step)	SB 9' 10" SB 3 m
	SBL DIST. (Surround back left speaker distance)	SBL 3' 3" to SBL 32' 9" (1 inch step) SBL 1.0 to SBL 10.0 (m) (1 cm step)	SBL 9' 10" SBL 3 m
	SBR DIST. (Surround back right speaker distance)	SBR 3' 3" to SBR 32' 9" (1 inch step) SBR 1.0 to SBR 10.0 (m) (1 cm step)	SBR 9' 10" SBR 3 m
	LH DIST. (Left high speaker distance)	LH 3' 3" to LH 32' 9" (1 inch step) LH 1.0 to LH 10.0 (m) (1 cm step)	LH 9' 10" LH 3 m
	RH DIST. (Right high speaker distance)	RH 3' 3" to RH 32' 9" (1 inch step) RH 1.0 to RH 10.0 (m) (1 cm step)	RH 9' 10" RH 3 m
	SW DIST. (Subwoofer distance)	SW 3' 3" to SW 32' 9" (1 inch step) SW 1.0 to SW 10.0 (m) (1 cm step)	SW 9' 10" SW 3 m
	DIST. UNIT (Distance unit)	METER, FEET	FEET

Menu	Item	Parameter	Initial setting
Speaker settings <SPEAKER>	FRT CROSS* (Front speakers crossover frequency)	CROSS 40 Hz to CROSS 200 Hz (10 Hz step)	CROSS 120 Hz
	CNT CROSS* (Center speaker crossover frequency)	CROSS 40 Hz to CROSS 200 Hz (10 Hz step)	CROSS 120 Hz
	SUR CROSS* (Surround speakers crossover frequency)	CROSS 40 Hz to CROSS 200 Hz (10 Hz step)	CROSS 120 Hz
	FH CROSS* (Front high speakers crossover frequency)	CROSS 40 Hz to CROSS 200 Hz (10 Hz step)	CROSS 120 Hz
	SP IMP. (Speaker Impedance)	8 ohm, 4 ohm	8 ohm
Surround settings <SURROUND>	EFFECT (HD-D.C.S. effect type)	DYNAMIC, THEATER, STUDIO	THEATER
	H. GAIN (PLIIZ Height Gain Control)	HIGH, MID, LOW	MID
EQ settings <EQ>	FRT BASS (Front speakers bass level)	FRT B. -10 dB to FRT B. +10 dB (0.5 dB step)	FRT B. 0 dB
	FRT TREBLE (Front speakers treble level)	FRT T. -10 dB to FRT T. +10 dB (0.5 dB step)	FRT T. 0 dB
	CNT BASS (Center speaker bass level)	CNT B. -10 dB to CNT B. +10 dB (0.5 dB step)	CNT B. 0 dB
	CNT TREBLE (Center speaker treble level)	CNT T. -10 dB to CNT T. +10 dB (0.5 dB step)	CNT T. 0 dB
	SUR BASS (Surround speakers bass level)	SUR B. -10 dB to SUR B. +10 dB (0.5 dB step)	SUR B. 0 dB
	SUR TREBLE (Surround speakers treble level)	SUR T. -10 dB to SUR T. +10 dB (0.5 dB step)	SUR T. 0 dB
	FH BASS (Front high speakers bass level)	FH B. -10 dB to FH B. +10 dB (0.5 dB step)	FH B. 0 dB
	FH TREBLE (Front high speakers treble level)	FH T. -10 dB to FH T. +10 dB (0.5 dB step)	FH T. 0 dB
Multi Zone settings <ZONE>	P.VOL MAIN (Preset Volume (MAIN))	OFF, $-\infty$, -92.0 dB to +23.0 dB (0.5 dB step)	OFF
	P.VOL ZONE2 (Preset Volume (Zone2))	OFF, $-\infty$, -92 dB to +18 dB (1 dB step)	OFF
	Z2 LINEOUT (Zone2 Line Out Level Type)	FIXED, VARIABLE	VARIABLE
	12V TRIG. (12V Trigger)	OFF, CTRL, ZONE, INPUT, HDMIA, HDMIB	OFF

* You cannot select this setting when the speaker is set to "LARGE."

Menu	Item	Parameter	Initial setting
Tuner settings <TUNER>	FM MODE	STEREO, MONO	STEREO
	NAME IN (Naming preset stations)	For reference on this function, see “Naming preset stations (Name Input)” (page 64)	
	PARENTAL (Sirius Parental Lock)	LOCK ON, LOCK OFF	LOCK OFF
	CODE EDIT (Sirius Lock Code Edit)	For reference on this function, see “Restricting access to specific channels (Parental Lock)” (page 68).	0000
	SR ANT AIM (Sirius Antenna Aiming)	For reference on this function, see “Checking the ID number” (page 66).	
	SIRIUS ID	For reference on this function, see “Checking the ID number” (page 66).	
Audio settings <AUDIO>	D.L.L.	D.L.L. AUTO2, D.L.L. AUTO1, D.L.L. OFF	D.L.L. AUTO1
	A/V SYNC (Synchronizes audio with video output)	0 ms to 300 ms (10 ms step)	0 ms
	DUAL MONO (Digital broadcast language selection)	MAIN/SUB, MAIN, SUB	MAIN
	DEC. PRIO (Digital audio input decoding priority)	DEC. AUTO, DEC. PCM	DEC. AUTO
	NIGHT MODE	NIGHT ON, NIGHT OFF	NIGHT OFF
	A. ASSIGN (Audio input assignment)	For reference on this function, see “Enjoying the sound/images from other inputs (Input Assign)” (page 102).	

Menu	Item	Parameter	Initial setting
Video settings <VIDEO>	RESOLUTION	DIRECT, AUTO, 480/576i, 480/576p, 720p, 1080i, 1080p	AUTO
	ZONE RESO. (Zone2 resolution)	480/576i, 480/576p, 720p, 1080i	480/576i
	V. ASSIGN (Video input assignment)	For reference on this function, see “Enjoying the sound/images from other inputs (Input Assign)” (page 102).	
HDMI settings <HDMI>	CTRL: HDMI (Control for HDMI)	CTRL ON, CTRL OFF	CTRL OFF
	PASS THRU (Pass Through)	ON, OFF	OFF
	AUDIO OUT	AMP, TV+AMP	AMP
	SW LEVEL (Subwoofer level for HDMI)	SW AUTO, SW +10 dB, SW 0 dB	SW AUTO
	SW LPF (Subwoofer LPF for HDMI)	LPF ON, LPF OFF	LPF ON
	V. DIRECT (Video direct)	DIRECT ON, DIRECT OFF	DIRECT OFF
System settings <SYSTEM>	DIMMER	0%DOWN, 60%DOWN, 100%DOWN	0%DOWN
	NAME IN (Naming inputs)	For reference on this function, see “Naming the input (Name Input)” (page 58).	
	RS232C	ON, OFF	OFF
	AUTO STBY	ON, OFF	ON
	VER ■■■■		
	UPDATE(PC)	PERMIT, DENY	DENY

To change the display

You can check the sound field, etc., by changing the information on the display.

- 1 Select the input for which you want to check the information.
- 2 Press DISPLAY repeatedly.
Each time you press DISPLAY, the display will change as follows.
Input you selected → Sound field type → Volume level → Stream information* → Input name you entered ...

* Stream information may not be displayed.

When listening to FM and AM radio
Station name → Frequency → Sound field type → Volume level ...

Index name appears only when you have assigned one to the input or preset station. Index name does not appear when only blank spaces have been entered.

When tuning in a channel from a SIRIUS
Channel name → Channel number → Category → Artist name → Song title → Composer name → Signal strength → Sound field type → Volume level ...

Operating Each Component Using the On-screen Remote (Quick Click)

Operating components or lighting connected to the receiver using the on-screen remote (Quick Click)

You can control components connected to the receiver, a projector, and the light control unit using the on-screen remote on the TV screen.

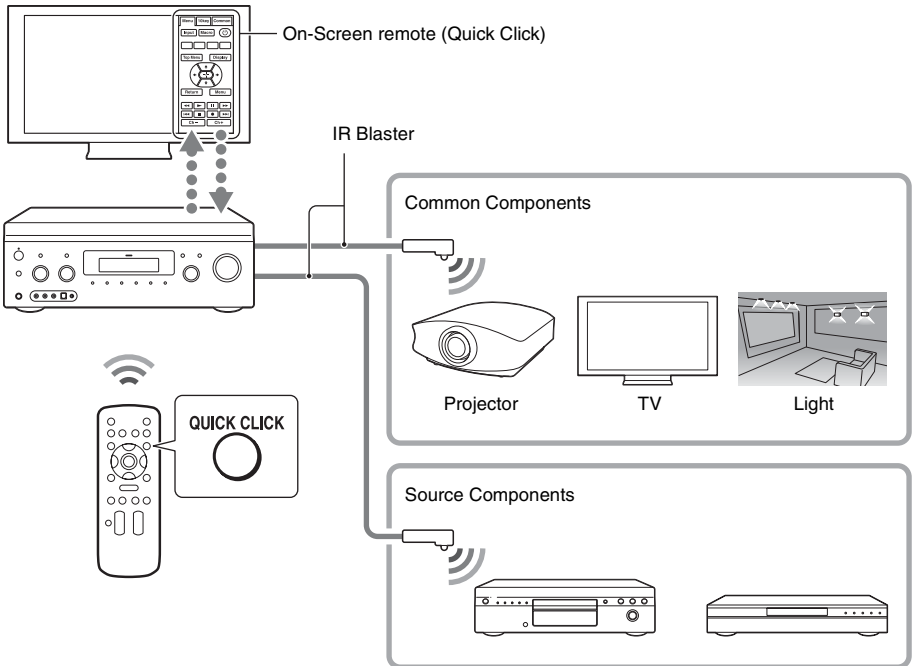

Using Quick Click

You can control components connected to the receiver, a TV, projector, or lighting using the on-screen remote on the TV screen.

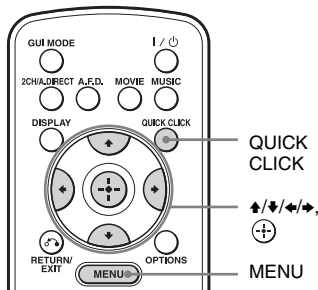

- 1** Select “ Input” from the menu, then press or .
- 2** Select the component you want, then press .
- 3** Press QUICK CLICK.
- 4** Select the appropriated buttons on the on-screen remote to use the function listed in the table below, then press .

Note

You may not be able to operate some functions for the components you are using.

Table of buttons used to control each component (Quick Click)

See “Operating the components connected to the receiver” (page 138) for details on the buttons of the on-screen remote.

Category	TV	VCR	PROJECTOR	DVD	BD	LD	CD	MD	CABLE	SAT	TAPE	DVR	LIGHT
Button													
	●	●	●	●	●	●	●	●	●	●	●	●	●
10 key	●	●	–	●	●	●	●	●	●	●	●	●	●
+10 (●)	●	–	–	●	●	●	●	●	●	●	–	●	–
Ent	●	●	–	●	●	●	●	●	●	●	●	●	●
Input	●	●	●	●	●	–	–	–	●	●	–	●	–
Display (Info)	●	●	●	●	●	●	●	●	●	●	●	●	●
Top Menu (Guide)	●	–	–	●	●	–	–	–	●	●	–	●	–
	–	●	–	●	●	●	●	●	●	●	●	●	●
	–	●	–	●	●	–	–	●	●	●	●	●	●
	–	–	–	●	●	●	●	●	●	●	●	●	●
	●	●	●	●	●	–	–	–	●	●	–	●	–
Ch +/-	●	●	–	●	●	–	–	–	●	●	–	●	–
Color buttons (Red/Blue/Green/Yellow)	●	–	–	●	●	–	–	–	–	●	–	●	–
Scene 1-16	–	–	–	–	–	–	–	–	–	–	–	–	●
All On/Off	–	–	–	–	–	–	–	–	–	–	–	–	●
On/Off	–	–	–	–	–	–	–	–	–	–	–	–	●
Raise/Lower	–	–	–	–	–	–	–	–	–	–	–	–	●

continued

Button

Light Off	●
Toggle	●

Operating the components connected to the receiver

You can control components connected to the receiver using the “Menu” and “10 key” features of Quick Click.

The following explanation provides examples of normal operation. The component may work differently, or may not work at all depending on the component.

Menu tab

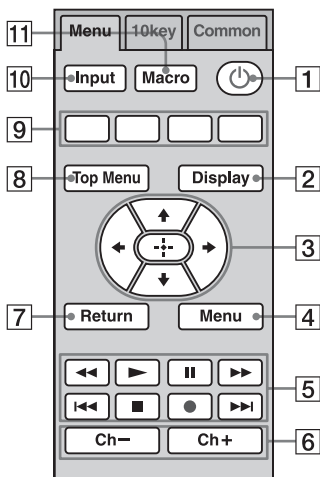

Button	Function
1	Select to turn components connected to the receiver on or off.
2 Display (Info)	Select to display the current status of or information on components connected to the receiver.

Button	Function
3	Select to select menu items. Then press to enter the selection.
4 Menu	Select to display the menu of components connected to the receiver.
5	Select to start playback or to record. Select to stop or pause playback or recording. Select to fast-forward or fast-reverse. Select to go to the next/previous track.
6 Ch+/Ch-	Select Ch +/- to select the channel of the TV, satellite tuner, VCR, etc.
7 Return (Exit)	Select to return to the previous menu or exit the menu.
8 Top Menu (Guide)	Select to display the top menu of the DVD player or Blu-ray Disc Player, etc., or display the program guide of a TV, satellite tuner or hard disk recorder, etc.
9 Color buttons (Red/Blue/Green/Yellow)	Select when you operate a DVD player/recorder, Blu-ray Disc Player, or cable box.
10 Input	Select the input source of the components connected to the receiver.
11 Macro	Select to start a macro programmed with Quick Click. When there are no programmed macros, this button does not appear.

10 key tab

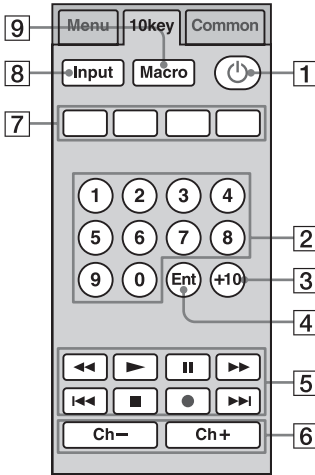

Button	Function
1	Select to turn components connected to the receiver on or off.
2 10 key	Select to <ul style="list-style-type: none"> select track numbers of the CD player, DVD player, Blu-ray Disc Player, or MD deck. select channel numbers of the TV, Satellite tuner or the VCR.
3 +10 (.)	Select to <ul style="list-style-type: none"> select track numbers over 10 of the CD player, DVD player, Blu-ray Disc Player, or MD deck. select channel numbers over 10 of the TV, Satellite tuner or the VCR.
4 Ent	Press to enter the value after selecting a channel, disc or track using the numeric buttons.

Button	Function
5	Select to start playback or to record.
	Select to stop or pause playback or recording.
	Select to fast-forward or fast-reverse.
	Select to go to the next/previous track.
6 Ch+/Ch-	Select Ch +/- to select the channel of the TV, satellite tuner, VCR, etc.
7 Color buttons (Red/Blue/Green/Yellow)	Select when you operate a DVD player/recorder, Blu-ray Disc Player, or cable box.
8 Input	Select the input source of components connected to the receiver.
9 Macro	Select to start a macro programmed with Quick Click. When there are no programmed macros, this button does not appear.

Operating the TV, projector or lighting

To operate the TV, select (☐) on Common tab.

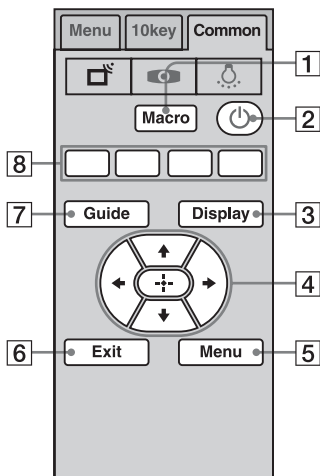

Button	Function
1 Macro	Select to start a macro programmed with Quick Click. When there are no programmed macros, this button does not appear.
2	Select to turn components connected to the receiver on or off.
3 Display (Info)	Select to display the current status of or information on components connected to the receiver.
4	Select /// to select menu items. Then press to enter the selection.
5 Menu	Select to display the menu of the components connected to the receiver.
6 Exit	Select to exit the menu.
7 Guide	Select to display the program guide of a TV, satellite tuner, hard disk recorder, etc.

Button	Function
8 Color buttons (Red/Blue/Green/Yellow)	Select when you operate a DVD player/recorder, Blu-ray Disc Player, or cable box.

To operate the projector, select (👁) on Common tab.

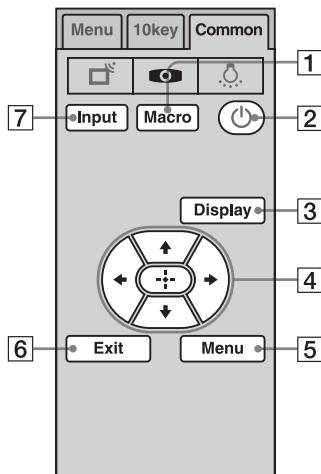

Button	Function
1 Macro	Select to start a macro programmed with Quick Click. When there are no programmed macros, this button does not appear.
2	Select to turn components connected to the receiver on or off.
3 Display (Info)	Select to display the current status of or information on components connected to the receiver.
4	Select /// to select menu items. Then press to enter the selection.
5 Menu	Select to display the menu of components connected to the receiver.
6 Exit	Select to exit the menu.

Button	Function
7 Input	Select the input source of the components connected to the receiver.

Button	Function
10 Macro	Select to start a macro programmed with Quick Click. When there are no programmed macros, this button does not appear.

To operate the lighting, select () on Common tab.

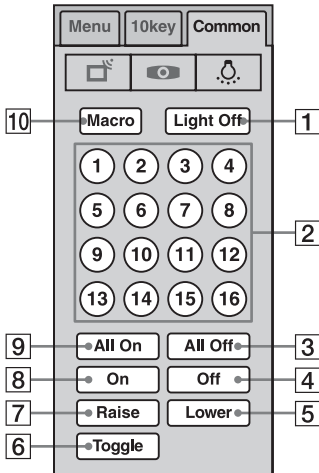

* A lighting control unit is a device which can adjust the brightness of two or more lights with a one-touch operation.
Consult your installation dealer about lighting control unit installation.

To make the on-screen remote disappear

Press QUICK CLICK or RETURN/EXIT ().

Button	Function
1 Light Off	Select to turn off the power of the lighting control unit.*
2 Scene 1~16	Select to select a preset lighting pattern.
3 All Off	Select to turn down the brightness of all the lights to the minimum (putting out the lights).
4 Off	Select to turn off a single light.
5 Lower	Select to turn down the brightness of all the lights at the same time.
6 Toggle	Select to switch the preset lighting pattern.
7 Raise	Select to turn up the brightness of all the lights at the same time.
8 On	Select to turn on a single light.
9 All On	Select to turn up all the lights to maximum brightness.

Setting components that are operated by the on-screen remote

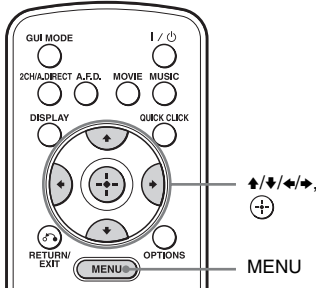

- 3 Select “Common Component,” then press \oplus .
- 4 Select the type of component you want to set up, then press \oplus .
- 5 Select “Preset Mode,” then press \oplus .
- 6 Select the component you want to set up, then press \oplus .
- 7 Select the maker name, then press \oplus .
- 8 Select the code, then press \oplus .
If you want to have a test, select “Menu” or “Power” on the TV screen.
If you selected “TV” in step 6, “Menu” appears., In other cases, “Power” appears.
- 9 Select “Finish,” then press \oplus .

To set the source component

- 1 Select “ Settings” from the menu, then press \oplus or \rightarrow .
- 2 Select “Quick Click,” then press \oplus .
- 3 Select “Source Component,” then press \oplus .
- 4 Select the input (including a TV) for the component you want to set up, then press \oplus .
- 5 Select “Preset Mode,” then press \oplus .
- 6 Select the type of component you want to set up, then press \oplus .
- 7 Select the maker name, then press \oplus .
- 8 Select the code, then press \oplus .
If you want to have a test, select “Play” on the TV screen.
- 9 Select “Finish,” then press \oplus .

To set the common component

- 1 Select “ Settings” from the menu, then press \oplus or \rightarrow .
- 2 Select “Quick Click,” then press \oplus .





Performing several commands in sequence automatically with Quick Click

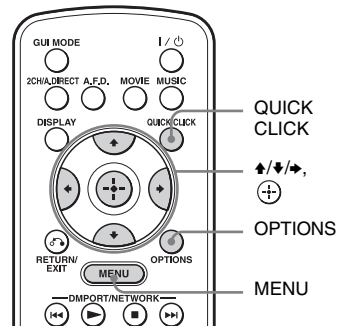

(Macro Play)

You can use the macro function easily with Quick Click.



- 1 Select “ Settings,” then press \oplus or \rightarrow .

- 2** Select “Quick Click,” then press .
- 3** Select “Macro,” then press .
- 4** Select the macro number for which you want to program the sequence of operation(s), then press .
- 5** Select the step number you want to set, then press .
- 6** Select the component type you want, or “- Wait -,” then press .

If you select “- Wait -,” go to step 8.
- 7** Select the key, then press .
- 8** Select the duration of time you want, then press .
- 9** Repeat steps 6 to 8 when you want to program operations for other components.

Starting macro play





- 1** Press QUICK CLICK.

The on-screen remote is displayed on the TV screen.
- 2** Select MACRO on on-screen remote.





The macro list appears on the TV screen.
- 3** Select the macro number you want to start.



The macro starts and executes the commands in the order you assigned them.

To input a macro name

- 1** Select “ Settings” from the menu, then press  or .
- 2** Select “Quick Click,” then press .









- 3** Select “Macro,” then press .
- 4** Press OPTIONS.

The option menu appears.
- 5** Select “Name Input,” then press .
- 6** Press / to select a character, then press .

You can shift input position backward and forward by pressing /.
- 7** Repeat steps 6 to input a character one by one, then press .

The name you entered is registered.

To erase a programmed macro

- 1** Select “ Settings” from the menu, then press  or .
- 2** Select “Quick Click,” then press .
- 3** Select “Macro,” then press .
- 4** Select the macro number you want, then press .
- 5** Select the step number you want, then press .
- 6** Select “-” as a component name, then press .
- 7** Repeat steps 5 and 6 to clear the stored macro.

Setting remote control codes that are not stored in Quick Click

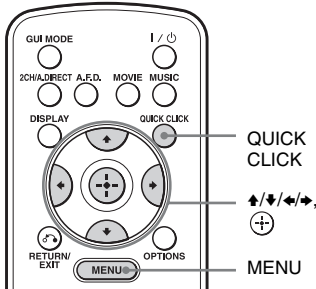

- 1** Select “ Settings” from the menu, then press or .
- 2** Select “Quick Click,” then press .
- 3** Select “Source Component,” or “Common Component,” then press .
- 4** Select the component you want, then press .
- 5** Select “Learn Mode,” then press .
- 6** Select the code number you want to store as the new command, then press .
- 7** Keep pressing the corresponding button on the remote of the component to be programmed while pointing the remote toward the receiver’s remote sensor until “Complete” is displayed on the TV screen.

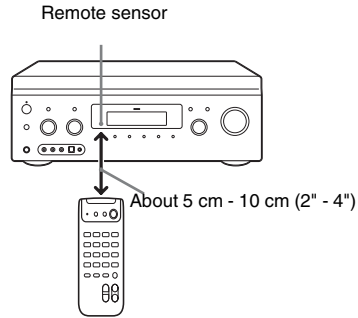

“Test” is selected automatically after few seconds when the registration of a new code is completed.

8 Press .

The operation test of the programmed code is started. Proceed to step 9 if you will not perform the operation test.

9 Select “Finish,” then press .

Note

The display window is turned off while the receiver is registering the new code.

To use a command that has been learned

- 1** Select “ Input” from the menu, then press or .
- 2** Select the component you want, then press .
- 3** Press QUICK CLICK.
- 4** Select the button on the on-screen remote used to learn that function, then press .

Resetting the remote code for Quick Click

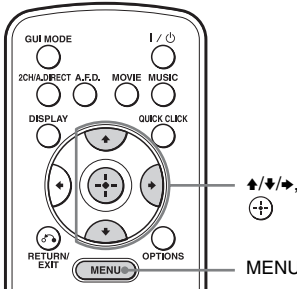

- 1** Select “ Settings” from the menu, then press or .
 - 2** Select “Quick Click,” then press .
 - 3** Select “Source Component,” or “Common Component,” then press .
 - 4** Select the component you want, then press .
 - 5** Select “Reset,” then press .
The confirming message appears on the TV screen.
 - 6** Select “Yes,” then press .
- All the contents of the selected input (e.g., all the programmed data) are cleared.
- 7** Repeat steps 4 to 6 to clear all programmed data.

Note

The macro itself is not cleared. A default code will be output when you have set a preset code or learned code in the macro step.

Operating Each Component Using the Multifunction Remote

Operating each component using the multifunction remote

You can control Sony or non-Sony components you are using with the multifunction remote supplied with the receiver.

The remote is initially set to control Sony components.

When you change the settings of the remote according to the components you are using, you can control non-Sony and other Sony components that the remote is initially unable control (page 147).

Operating the components connected to the receiver

- 1 Press the input button that matches the connected component that you want to operate.
- 2 Press the appropriated buttons to use the function listed in the table below.

Note

You may not be able to operate some functions for the components you are using.

Table of buttons used to control each component

Component	TV	VCR	DVD player, DVD/VCR combo	Blu-ray Disc Player	HDD Recorder	PSX	Video player, LD player	CD player, LD player	Digital terminal	CATV	DSS	Tape deck A/B	DAT deck	CD player, MD deck	DIGITAL MEDIA PORT device
Button															
AV I/O	●	●	●	●	●	●	●	●	●	●	●	●	●	●	
Numeric buttons	●	●	●	●	●	●	●	●	●	●	●	●	●	●	●
TV INPUT	●														
GUIDE	●		● ^{c)}	●	●	●			●						
-/-	●	●	●	●	●	●	●	●	●	●	●	●	●	●	●
ENTER	●	●	●	●	●	●	● ^{a)}	●	●	●	●	●	●	●	●
Color buttons	●		● ^{c)}	●	●										
TOOLS/OPTIONS	●		●	●	●	●			●		●				
DISPLAY	●	●	●	●	●	●	●	●	●	●	●			●	
RETURN/EXIT	●		●	●	●	●	●	●	●	●	●				●
↔/↔/↔, ⊕, MENU, HOME	●	●	●	●	●	●	●	●	●	●	●				●
⏮/⏭	●	●	●	●	●	●	●	●	●	●	● ^{b)}	●	●	●	●
↔/↔	●		●	●	●	●			●						●
⏪/TUNING -, ⏩/TUNING +	●	●	●	●	●	●	●	●	●	●	●	●	●	●	●
DISC SKIP			● ^{c)}				● ^{d)}							●	
▶, II, ■	●	●	●	●	●	●	●	●	●	●	●	●	●	●	●

Component	TV	VCR	DVD player, DVD/VCR combo	Blu-ray Disc Player	HDD Recorder	PSX	Video CD player, LD player	Digital CATV terminal	DSS	Tape deck A/B	DAT deck	CD player, MD deck	DIGITAL MEDIA PORT device
Button													
MUTING, MASTER VOL +/-, TV VOL +/-	●												
PRESET +/-, TV CH +/-	●	●	●	●	●		● ^{a)}	●	●				
BD/DVD TOP MENU, BD/DVD MENU			●	●		●							
F1, F2			●	●									

- a) LD player only
- b) Deck B only
- c) DVD only
- d) Video CD only

Programming the remote

You can customize the remote to match the components connected to your receiver. You can even program the remote to control non-Sony components and also Sony components that the remote is normally unable to control. The procedure below uses as an example a case in which a VCR made by a company other than Sony is connected to the VIDEO 2 IN jacks on the receiver.

2 While the RM SET UP button is flashing, press the input button (including the TV button) for the component you want to control.

For example, if you are going to control a VCR connected to VIDEO 2 IN jack, press VIDEO 2.

RM SET UP and SHIFT light up, and the input button flashes.

If you press the button for a component of which you cannot program the remote, such as TUNER, PHONO, DMPORT or SOURCE, etc., the RM SET UP button keeps flashing.

3 Press the numeric buttons to enter the numeric code (or one of the codes if more than one code exists) corresponding to the component and the maker of the component you want to control.

The input button lights up.

Note

As a remote code value for the TV button, only numbers in the 500's are valid.

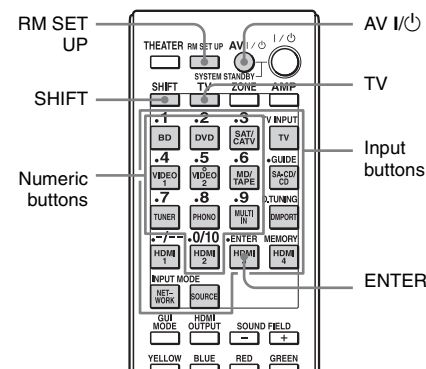

1 Press AV I/⏻ while pressing RM SET UP.

The RM SET UP button flashes.

4 Press ENTER.

Once the numeric code has been verified, the RM SET UP button flashes twice and the remote automatically exits the programming mode. The input button also turns off.

To cancel programming

Press RM SET UP during any step.

The numeric codes corresponding to the component and the maker of the component

Use the numeric codes in the tables below to control non-Sony components and also Sony components that the remote is initially unable to control. Since the remote signal that a component accepts differs depending on the model and year of the component, more than one numeric code may be assigned to a component. If you fail to program your remote using one of the codes, try using other codes.

Notes

- The numeric codes are based on the latest information available for each brand. There is a chance, however, that your component will not respond to some or all of the codes.
- All of the input buttons on this remote may not be available when used with your particular component.

To control a CD player

Maker	Code(s)
SONY	101, 102, 103
DENON	104, 123
JVC	105, 106, 107
KENWOOD	108, 109, 110
MAGNAVOX	111, 116
MARANTZ	116
ONKYO	112, 113, 114
PANASONIC	115
PHILIPS	116
PIONEER	117
TECHNICS	115, 118, 119
YAMAHA	120, 121, 122

To control a DAT deck

Maker	Code(s)
SONY	203
PIONEER	219

To control a tape deck

Maker	Code(s)
SONY	201, 202
DENON	204, 205
KENWOOD	206, 207, 208, 209
NAKAMICHI	210
PANASONIC	216
PHILIPS	211, 212
PIONEER	213, 214
TECHNICS	215, 216
YAMAHA	217, 218

To control an MD deck

Maker	Code(s)
SONY	301
DENON	302
JVC	303
KENWOOD	304

To control an HDD recorder

Maker	Code(s)
SONY	307, 308, 309

To control a Blu-ray Disc Player

Maker	Code(s)
SONY	310, 311, 312
PANASONIC	335
SAMSUNG	336
LG	337

To control a PSX

Maker	Code(s)
SONY	313, 314, 315

To control a DVD player

Maker	Code(s)
SONY	401, 402, 403
BROKSONIC	424
DENON	405
HITACHI	416

Maker	Code(s)
JVC	415, 423
MITSUBISHI	419
ORITRON	417
PANASONIC	406, 408, 425
PHILIPS	407
PIONEER	409, 410
RCA	414
SAMSUNG	416, 422
TOSHIBA	404, 421
ZENITH	418, 420

To control a DVD/VCR COMBO (recorder)

Maker	Code(s)
SONY	411

To control a HDD/DVD COMBO (recorder)

Maker	Code(s)
SONY	401, 402, 403

To control a TV

Maker	Code(s)
SONY	501
AIWA	501, 536, 539
AKAI	503
AOC	503
CENTURION	566
CORONADO	517
CURTIS-MATHES	503, 551, 566, 567
DAYTRON	517, 566
DAEWOO	504, 505, 506, 507, 515, 544
FISHER	508, 545
FUNAI	548
FUJITSU	528
GOLDSTAR/LG	503, 512, 515, 517, 534, 544, 556, 568, 576
GRUNDIG	511, 533, 534
HITACHI	503, 513, 514, 515, 517, 519, 544, 557, 571
ITT/NOKIA	521, 522
J.C.PENNY	503, 510, 566
JVC	516, 552
KMC	517
MAGNAVOX	503, 515, 517, 518, 544, 566
MARANTZ	527

Maker	Code(s)
MITSUBISHI/MGA	503, 519, 527, 544, 566, 568
NEC	503, 517, 520, 540, 544, 554, 566
NORDMENDE	530, 558
NOKIA	521, 522, 573, 575
PANASONIC	509, 524, 553, 559, 572
PHILIPS	515, 518, 557, 570, 571
PHILCO	503, 504, 514, 517, 518
PIONEER	509, 525, 526, 540, 551, 555
PORTLAND	503
QUASAR	509, 535
RADIO SHACK	503, 510, 527, 565, 567
RCA/PROSCAN	503, 510, 523, 529, 544
SAMSUNG	503, 515, 517, 531, 532, 534, 544, 556, 557, 562, 563, 566, 569
SAMPO	566
SABA	530, 537, 547, 549, 558
SANYO	508, 545, 546, 560, 567
SCOTT	503, 566
SEARS	503, 508, 510, 517, 518, 551
SHARP	517, 535, 550, 561, 565
SYLVANIA	503, 518, 566
THOMSON	530, 537, 547, 549
TOSHIBA	535, 539, 540, 541, 551
TELEFUNKEN	530, 537, 538, 547, 549, 558
TEKNIKA	517, 518, 567
WARDS	503, 517, 566
YORK	566
ZENITH	542, 543, 567
GE	503, 509, 510, 544
LOEWE	515, 534, 556

To control an LD player

Maker	Code(s)
SONY	601, 602, 603
PIONEER	606

To control a video CD player

Maker	Code(s)
SONY	605

To control a VCR

Maker	Code(s)
SONY	701, 702, 703, 704, 705, 706
AIWA*	710, 750, 757, 758
AKAI	707, 708, 709, 759
BLAUPUNKT	740
EMERSON	711, 712, 713, 714, 715, 716, 750
FISHER	717, 718, 719, 720
GENERAL ELECTRIC (GE)	721, 722, 730
GOLDSTAR/LG	723, 753
GRUNDIG	724
HITACHI	722, 725, 729, 741
ITT/NOKIA	717
JVC	726, 727, 728, 736
MAGNAVOX	730, 731, 738
MITSUBISHI/MGA	732, 733, 734, 735
NEC	736
PANASONIC	729, 730, 737, 738, 739, 740
PHILIPS	729, 730, 731
PIONEER	729
RCA/PROSCAN	722, 729, 730, 731, 741, 747
SAMSUNG	742, 743, 744, 745
SANYO	717, 720, 746
SHARP	748, 749
TELEFUNKEN	751, 752
TOSHIBA	747, 756
ZENITH	754

* If an AIWA VCR does not work even though you enter the code for AIWA, enter the code for Sony instead.

To control a satellite tuner (box)

Maker	Code(s)
SONY	801, 802, 803, 804, 824, 825, 865
AMSTRAD	845, 846
BskyB	862
GENERAL ELECTRIC(GE)	866
GRUNDIG	859, 860
HUMAX	846, 847
THOMSON	857, 861, 864, 876
PACE	848, 849, 850, 852, 862, 863, 864
PANASONIC	818, 855

Maker	Code(s)
PHILIPS	856, 857, 858, 859, 860, 864, 874
NOKIA	851, 853, 854, 864
RCA/PROSCAN	866, 871
HITACHI/BITA	868
HUGHES	867
JVC/Echostar/Dish Network	873
MITSUBISHI	872
SAMSUNG	875
TOSHIBA	869, 870

To control a cable box

Maker	Code(s)
SONY	821, 822, 823
HAMLIN/REGAL	836, 837, 838, 839, 840
JERROLD/G.I./MOTOROLA	806, 807, 808, 809, 810, 811, 812, 813, 814, 819
JERROLD	830, 831
OAK	841, 842, 843
PANASONIC	816, 826, 832, 833, 834, 835
PHILIPS	830, 831
PIONEER	828, 829
RCA	805
SCIENTIFIC ATLANTA	815, 816, 817
TOCOM/PHILIPS	830, 831
ZENITH	826, 827

Performing several commands in sequence automatically

(Macro Play)

The Macro Play function lets you link several commands in a sequential order as a single command.

The remote provides 2 macro lists (MACRO 1 and MACRO 2). You can specify up to 20 commands for each macro list.

Note

When setting up Macro Play, replace the batteries with new ones.

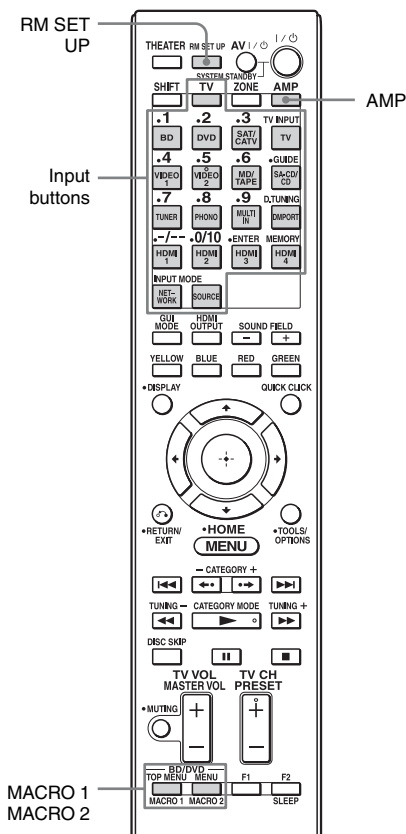

Program the sequence of the operation

- 1 Press MACRO 1 or MACRO 2 for more than 1 second while pressing RM SET UP.**

The RM SET UP button flashes and one of the input buttons lights up (as the initial setting, the BD button lights).

- 2 Press the input button for the component for which you want to program the sequence of operation(s).**

- 3 Press the buttons you want to program in the same sequence as you want the operation(s) to be performed.**

You can program particular operations using the following buttons.

Press	Operations to be programmed
The input button for more than 1 second	Switches inputs.
MACRO 1 or MACRO 2	Make a one second interval. When you want to make a longer interval, press MACRO 1 or MACRO 2 repeatedly.

The input button selected in step 2 flashes twice, then lights up again.

- 4 Repeat steps 2 and 3 when you want to program operations for other components.**
- 5 Press RM SET UP to finish the programming process.**

Tip

If the RM SET UP button flashes five times in step 1, and the macro programming process does not start, replace the batteries with new ones.

To cancel programming

Not pressing any button for 60 seconds cancels the settings.

The previous command remains valid.

Starting macro play

1 Press AMP.

The AMP button lights up, and then turns off.

2 Press MACRO 1 or MACRO 2 to start the macro.

The macro starts and execute the commands in the order you assigned them. While the commands are being sent, the AMP button flashes and the RM SET UP button lights up. When the commands have been sent, the RM SET UP and AMP buttons turn off.

To erase a programmed macro

1 Press MACRO 1 or MACRO 2 for more than 1 second while pressing RM SET UP to clear the stored macro. The RM SET UP button flashes.

2 Press RM SET UP.

Settings stored as macro are cleared.

Setting remote commander codes that are not stored in the remote

Even if a remote commander code is not one of the presets stored in the remote, it is possible for the remote to learn the code using the learning function.

Note

When setting up the receiver to learn the remote command modes, replace the batteries with new ones.

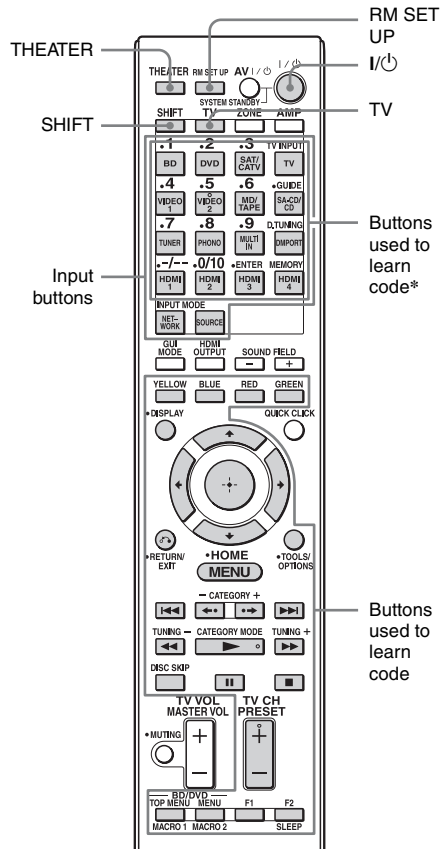

* To store a new command on one of those buttons, press SHIFT beforehand.

1 Press THEATER while pressing RM SET UP.

The RM SET UP button lights up.

2 Press the input button (including the TV button) for the component you want to operate with the new command.

The input button flashes. (The RM SET UP button remains lit.)

3 Press the button on which you want to store the new command. For the buttons with an asterisk in the illustration above, press SHIFT, then press the button.

The input button you selected in step 2 lights up. (The RM SET UP button remains lit.)

4 Point the remote code receiver section of the remote toward the transmitter on the remote commander to be learned from.

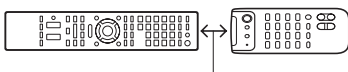

About 5 cm - 10 cm (2" - 4")

5 Press the button on the remote commander to be learned from to transmit the remote code.

While the remote of the receiver is receiving the signal, the input button selected in step 2 turns off.

The RM SET UP button flashes twice, then the learning process is completed.

When the learning process fails, the RM SET UP button flashes five times. Try to perform process again from step 2.

6 Press RM SET UP to finish the learning function process.

Tips

- When the memory capacity for storing remote commander codes reaches a certain limit, the RM SET UP button flashes 10 times, and then the learning process ends.
- If the RM SET UP button flashes five times in step 1, and the learning process does not start, replace the batteries with new ones.
- If you want to store the new command on the button on which you have already stored the command, erase the stored command beforehand.

To cancel learning

Press RM SET UP. Also, not pressing any button for 60 seconds cancels the settings.

Using a command that has been learned

When selecting a learned input, press the button used to learn that function.

To erase the learned code

- 1 Press THEATER while pressing RM SET UP.
- 2 Press the input button for which you want to clear the setting.
The input button flashes. (The RM SET UP button remains lit.)
- 3 Press I/⏻ for more than 1 second.
The input button flashes twice, repeatedly.
- 4 Press the button which learned the command to clear the stored setting.
The RM SET UP button flashes twice, then the clearing process is completed.
When the clearing process fails, the RM SET UP button flashes five times. Try to perform process again from step 2.
- 5 Press RM SET UP to finish the erasing process.

Clearing all the contents of the remote's memory

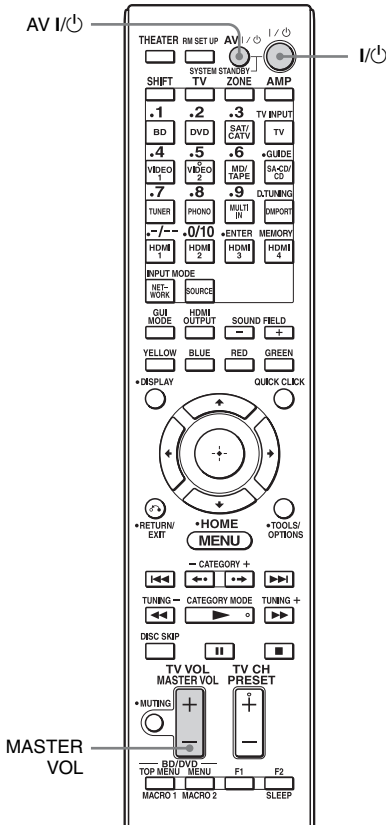

- 1 Hold down I/⏻ while pressing MASTER VOL -, then press AV I/⏻, all at the same time.**

The RM SET UP button flashes three times.

- 2 Release all buttons.**

All the contents of the remote's memory (e.g., all the programmed data) are cleared.

Precautions

On safety

Should any solid object or liquid fall into the cabinet, unplug the receiver and have it checked by qualified personnel before operating it any further.

On power sources

- Before operating the receiver, check that the operating voltage is identical with your local power supply.
The operating voltage is indicated on the nameplate on the back of the receiver.
- The unit is not disconnected from the AC power source (mains) as long as it is connected to the wall outlet, even if the unit itself has been turned off.
- If you are not going to use the receiver for a long time, be sure to disconnect the receiver from the wall outlet. To disconnect the AC power cord (mains lead), grasp the plug itself; never pull the cord.
- One blade of the plug is wider than the other for the purpose of safety and will fit into the wall outlet only one way. If you are unable to insert the plug fully into the outlet, contact your dealer.
- AC power cord (mains lead) must be changed only at a qualified service shop.

On heat buildup

Although the receiver heats up during operation, this is not a malfunction. If you continuously use this receiver at a large volume, the cabinet temperature of the top, side and bottom rises considerably. To avoid burning yourself, do not touch the cabinet.

On placement

- Place the receiver in a location with adequate ventilation to prevent heat buildup and prolong the life of the receiver.
- Do not place the receiver near heat sources, or in a place subject to direct sunlight, excessive dust, or mechanical shock.
- Do not place anything on top of the cabinet that might block the ventilation holes and cause malfunctions.
- Do not place the receiver near equipment such as a television, VCR, or tape deck. (If the receiver is being used in combination with a television, VCR, or tape deck, and is placed too close to that equipment, noise may result, and picture quality may suffer. This is especially likely when using an indoor antenna (aerial). Therefore, we recommend using an outdoor antenna (aerial).)

On operation

Before connecting other components, be sure to turn off and unplug the receiver.

On cleaning

Clean the cabinet, panel, and controls with a soft cloth slightly moistened with a mild detergent solution. Do not use any type of abrasive pad, scouring powder, or solvent, such as alcohol or benzene.

If you have any questions or problems concerning your receiver, please consult your nearest Sony dealer.

Troubleshooting

If you experience any of the following difficulties while using the receiver, use this troubleshooting guide to help you remedy the problem. Should any problem persist, consult your nearest Sony dealer.

General

The receiver is turned off automatically.

- “Auto Standby” is set to “ON” (page 127).
- The sleep timer function is working (page 104).

“ Settings” of the GUI does not appear on the TV screen, or the surround effect does not switch.

- “Settings Lock” is set to “ON” (page 127).

Audio

There is no sound, no matter which component is selected, or only a very low-level sound is heard.

- Check that the speakers and components are connected securely.
- Check that all speaker cords are connected correctly.
- Check that both the receiver and all components are turned on.
- Check that MASTER VOLUME control is not set at $-\infty$ dB. Try to set it at about -40 dB.
- Check that SPEAKERS (A/B/A+B/OFF) is not set to OFF (page 45).
- Press MUTING on the remote to cancel the muting function.
- Check that you have selected the correct component with INPUT SELECTOR.
- Check that headphones are not connected.
- Check to see if Night Mode is activated (page 104).

- The protective device on the receiver has been activated. Turn off the receiver, eliminate the short-circuit problem, and turn on the power again.

There is no sound from a specific component.

- Check that the component is connected correctly to the audio input jacks for that component.
- Check that the cord(s) used for the connection is (are) fully inserted into the jacks on both the receiver and the component.
- Set the INPUT MODE to “AUTO” (page 101).

There is no sound from one of the front speakers.

- Connect a pair of headphones to the PHONES jack to verify that sound is output from the headphones. If only one channel is output from the headphones, the component may not be connected to the receiver correctly. Check that all the cords are fully inserted into the jacks on both the receiver and the component. If both channels are output from the headphones, the front speaker may not be connected to the receiver correctly. Check the connection of the front speaker which is not outputting any sound.
- Make sure you have connected both the L and R jacks to an analog component and not just to either the L or R jack. Use a monaural-stereo cable (not supplied). However, there will be no sound from the center speaker when a sound field (Pro Logic, etc.) is selected. When the center speaker is not connected, sound is output only from the front left/right speakers.

There is no sound from analog 2 channel sources.

- Check to make sure the selected audio (digital) input jack is not assigned to other inputs in “Input Assign” in the Input menu (page 102).

There is no sound from digital sources (from COAXIAL or OPTICAL input jack).

- Check the INPUT MODE (page 101).
- Check that the “2ch Analog Direct” is not being used.
- Check to make sure the selected audio (digital) input jack is not assigned to other inputs in “Input Assign” in the Input menu (page 102).

The source sound input from the HDMI IN jack is not output from an amplifier or the TV speaker connected to the receiver.

- Check that the component is connected correctly to the HDMI IN jack for that component.
- Depending on the playback component, component may need to be set up. Refer to the operating instructions supplied with the each component.
- Be sure to use a connecting cable for the HDMI jack corresponding to High Speed HDMI cable when you view images or listen to sound during a 1080p, Deep Color, or 3D transmission.
- Sound may not be output from the receiver while the GUI appears on the TV screen. Press GUI MODE to turn “GUI MODE” off.

The left and right sounds are unbalanced or reversed.

- Check that the speakers and components are connected correctly and securely.
- Adjust the balance parameters using the Auto Calibration settings menu.

There is severe hum or noise.

- Check that the speakers and components are connected securely.
- Check that the connecting cords are away from a transformer or motor, and at least 3 meters (10 feet) away from a TV set or fluorescent light.
- Move your TV away from the audio components.

- Make sure you have grounded the π SIGNAL GND terminal (only when a turntable is connected).
- The plugs and jacks are dirty. Wipe them with a cloth slightly moistened with alcohol.

There is no sound, or only a very low-level sound is heard from the center/surround/surround back speakers.

- Check that the speaker settings are appropriate using the Auto Calibration settings menu or “Speaker Pattern” in the Speaker settings menu. And then check that sound is output from each speaker correctly, using “Test Tone” in the Speaker settings menu.
- Select the “HD-D.C.S.” sound field (page 76).
- Adjust the speaker level (page 112).
- Make sure the center/surround speaker (s) is (are) set to either “Small” or “Large.”

There is no sound from the surround back speakers.

- Some discs have no Dolby Digital Surround EX flag even though the packages have Dolby Digital Surround EX logos.

There is no sound from the subwoofer.

- Check that the subwoofer is connected correctly and securely.
- Make sure you have turned on your subwoofer.
- When all speakers are set to “Large” and “Neo:6 Cinema,” or “Neo:6 Music” is selected, there is no sound from the subwoofer.

The surround effect cannot be obtained.

- Make sure the sound field function is on (press MOVIE/HD-D.C.S. or MUSIC).
- Sound fields do not work when Dolby TrueHD, DTS-HD, or Linear PCM signals with a sampling frequency of 88.2 kHz and higher are being received.

- “PLII (Music/Movie),” “PLIIX (Music/Movie),” “PLIIZ Height,” and “Neo:6 (Music/Cinema)” do not work when the speaker pattern is set to 2/0 or 2/0.1.

Dolby Digital or DTS multi-channel sound is not reproduced.

- Check that the DVD, etc., you are playing is recorded in Dolby Digital or DTS format.
- When connecting the DVD player, etc., to the digital input jacks of this receiver, make sure the setting for the digital audio output of the connected component is available.

Recording cannot be carried out.

- Check that the components are connected correctly (page 34).
- Select the source component (page 57).

The MULTI CHANNEL DECODING lamp does not light up in blue.

- Check that the playback component is connected on a digital jack and the input is selected properly on this receiver.
- Check whether the input source of the software being played back corresponds to the multi-channel format.
- Check whether the setup on the playback component is set to multi-channel sound.
- Check to make sure the selected audio (digital) input jack is not assigned to other inputs in “Input Assign” in the Input menu (page 102).

There is no sound from the component connected to the DIGITAL MEDIA PORT adapter.

- Adjust the volume of this receiver.
- The DIGITAL MEDIA PORT adapter and/or component is not connected correctly. Turn off the receiver, then reconnect the DIGITAL MEDIA PORT adapter and/or component.
- Check the DIGITAL MEDIA PORT adapter and/or component device to make sure it supports this receiver.

Video

There is no picture or an unclear picture appears on the TV screen or monitor.

- Select the appropriate input on the receiver (page 57).
- Set your TV to the appropriate input mode.
- Move your TV away from the audio components.
- Assign the component video input correctly.
- The input signal should be same as input when you are up-converting an input signal with this receiver (page 32).
- When you use an HDMI-DVI conversion cable for the connection, the image may not be output correctly.

The image of the COMPONENT VIDEO OUT is corrupted.

- The resolution of output signals from the COMPONENT VIDEO OUT jacks may not be supported by your TV. In this case, select the appropriate resolution on the receiver (page 121).

Images from the component connected to the HDMI jack are not output to the TV, are distorted, or are interrupted.

- The output of the HDMI video signals of the receiver may be set to “OFF.” In this case, select “HDMI A” or “HDMI B” using the HDMI OUTPUT button (page 99).
- If the compatible video format differs between the monitors connected to the HDMI OUT A jack and the HDMI OUT B jack of the receiver, “HDMI A B” may not work.
- Depending on the playback component you connect, “HDMI A B” may not work.
- Make sure that cables are correctly and securely connected to components.
- Depending on the playback component, component may need to be set up. Refer to the operating instructions supplied with the each component.

- Be sure to use a connecting cable for the HDMI jack corresponding to High Speed HDMI cable when you view images or listen to sound during a 1080p, Deep Color, or 3D transmission.
- Images from the component connected to the HDMI jack may be distorted. In this case, set “Video Direct” to “ON” in the HDMI settings menu.
- Images or sound from the component connected to the HDMI jack may be interrupted when video signals are switched. In this case, set “Video Direct” to “ON” in the HDMI settings menu.
- If the start of the video is not output when the 3D video is switched, or the colors of the 3D video are improper, set “Video Direct” to “ON” in the HDMI settings menu.

No 3D image appears on the TV.

- Depending on the TV or the video component, 3D images may not be displayed. Check the 3D image formats supported by the system (page 164).

Recording cannot be carried out.

- Check that the components are connected correctly (page 25).
- Select the source component (page 57).

The GUI does not appear on the TV screen.

- “GUI MODE” may have been turned off. Press GUI MODE to turn “GUI MODE” on.
- Check the TV is connected correctly.

Images appear later than the associated sound is played when the HDMI input is selected.

- Depending on the component connected to the HDMI jack, or the source played back, images may appear later than the associated sound. In this case, set “Video Direct” to “ON” in the HDMI settings menu.

Tuner

The FM reception is poor.

- Use a 75-ohm coaxial cable (not supplied) to connect the receiver to an outdoor FM antenna (aerial) as shown on page 159. If you connect the receiver to an outdoor antenna (aerial), ground it against lightning. To prevent a gas explosion, do not connect the ground (earth) wire to a gas pipe.

Outdoor FM antenna (aerial)

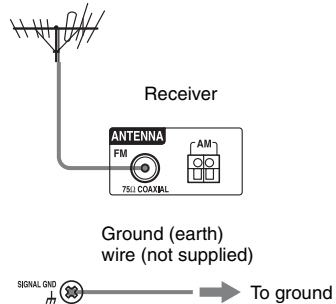

Radio stations cannot be tuned in.

- Check that the antennas (aerials) are connected securely. Adjust the antennas (aerials) and connect an external antenna (aerial), if necessary.
- Keep the satellite radio antenna, away from the speaker cords and the power cord to avoid picking up noise.
- The signal strength of the stations is too weak (when tuning in with automatic tuning). Use direct tuning.
- Make sure you set the tuning interval correctly (when tuning in AM stations with direct tuning).
- No stations have been preset or the preset stations have been cleared (when tuning by scanning preset stations). Preset the stations (page 64).
- Press DISPLAY so that the frequency appears on the display.

continued

The system cannot receive satellite channels at all.

- The receiving condition is not good. Move the antenna to the place where the condition is good.
- Check that you subscribed to the desired satellite radio service (page 65).

Control for HDMI

The Control for HDMI function does not work.

- Check the HDMI connection (page 25).
- Make sure “Control for HDMI” is set to “ON” in HDMI settings menu.
- Make sure the connected component is compatible with the Control for HDMI function.
- Check the Control for HDMI settings on the connected component. Refer to the operating instructions of the connected component.
- If you change the HDMI connection, connect/disconnect the AC power cord, or there is a power failure, repeat the procedures of “Preparing for the “BRAVIA” Sync” (page 97).
- If you select “HDMI A” or “HDMI A B,” after you have selected “HDMI B” or “OFF,” the Control for HDMI function may not work properly for a while. This is because the component connected to the HDMI OUT A jack must re-recognize the receiver that is equipped with the Control for HDMI function. If the Control for HDMI function does not work properly for a long time, perform the steps given in “Preparing for the “BRAVIA” Sync” (page 97).
- When you select “HDMI B” or “OFF,” the Control for HDMI function does not work properly.
- When “Control for HDMI” is set to “OFF,” the “BRAVIA” Sync does not work properly, even if a component is connected to the HDMI IN jack.

- The types and the number of components which can be controlled by the “BRAVIA” Sync are restricted in the HDMI CEC standard as follows.
 - Recording component (Blu-ray Disc recorder, DVD recorder, etc.): up to 3 components
 - Playback component (Blu-ray Disc Player, DVD player, etc.): up to 3 components
 - Tuner-related component: up to 4 components
 - AV receiver (audio system): up to 1 component

No sound is output from the receiver and TV speaker while using the System Audio Control function.

- Make sure the TV is compatible with the System Audio Control function.
- If the TV does not have System Audio Control function, set the “Audio Out” settings in HDMI settings menu to
 - “TV+AMP” if you want to listen to the sound from the TV speaker and receiver.
 - “AMP” if you want to listen to the sound from the receiver.
- When you connect the receiver to a video component (projector, etc.), sound may not be output from the receiver. In this case, select “AMP.”
- You cannot listen to the sound of a component connected to the receiver while a TV is selected as the input on the receiver.
 - Change the input of the receiver to HDMI when you want to watch a program on a component connected to the receiver.
 - Change the TV channel when you want to watch a TV broadcast.
 - Select the component or input you want to watch when you watch a program on the component connected to the TV. Refer to the operating instructions of the TV on this operation.

- When using the Control for HDMI function, you cannot control the connected component using TV's remote.
 - Depending on the connected component and TV, you may need to set up the component and TV. Refer to the operation instructions supplied with each component and TV.
 - Change the input of the receiver to the HDMI input connected to the component.

Remote commander

The remote does not function.

- Point the remote at the remote sensor on the receiver.
- Remove any obstacles in the path between the remote and the receiver.
- Replace all the batteries in the remote with new ones, if they are weak.
- Make sure that the command modes of the receiver and the remote are the same. If the command mode of the receiver and the remote are different, you cannot operate the receiver with the remote (page 106).
- Make sure you select the correct input on the remote.
- When you operate a programmed non-Sony component, the remote may not function properly depending on the model and the maker of the component.

Network

Cannot find the server.

- Search the server using the "Server Search" function (page 80).
- Check the following:
 - Is the router turned on?
 - If there is another device between this device and the router, check that device is turned on.
 - Are all of the cables connected correctly and securely?

- Is the settings to make sure that they match the router's settings (DHCP or fixed IP address)?
- When using a computer, check the following:
 - The built-in firewall settings for the computer's operating system.
 - The firewall settings of your security software. To check the firewall settings of your security software, refer to your security software's Help section.
- Register this device with the server. For details, refer to the instructions supplied with the server.
- Wait for a few moments, and then try connecting to the server again.

Cannot find or play back the content on the server.

- On the "🎵 Music," "📷 Photo," and "📺 Video" screens, the receiver displays only the content that can be played back with the receiver from among the content offered by the server within the DLNA guidelines.
- The content without a [*] mark before the name is offered by the server as that defined in the DLNA guidelines, and it can be played back with the receiver. The content with a [*] mark before the name is offered by the server as that not defined in the DLNA guidelines, and it may be played back with the receiver.
- There may be content that is not displayed even if it can be played back with the receiver because it is not defined in the DLNA guidelines. However, the receiver may not be able to play back the content, even if it is defined in the DLNA guidelines.
- The availability of certain content may differ, depending on the server software. If the content is not displayed or cannot be played back, try the supplied VAIO Media plus application software as your server software.

Cannot connect to the receiver with the Setup Manager application software.

- Does antivirus software, firewall software, or a network packet filter driver run on your computer?
Deactivate such software temporarily, or change the settings to accept all incoming TCP or UDP packets from the receiver.

Cannot access the receiver from the network controller.

- Make sure “External Control” is set to “ON” in Network settings menu.
- Is the network controller listed on the Controllers settings screen, and is the box for “Permit” checked?
If the box is not checked, check the box for “Auto Permission,” and return to the menu. Then, operate the receiver using the network controller once, and then uncheck the box for “Auto Permission.”
- If the network controller is a computer software controller, is the software filtered by antivirus software or firewall software? Permit UPnP communications between the software and the receiver.

If the trouble is other than one of the cases described above and the trouble is not solved even if you wait for a while, perform either of the operations below.

- Press I/⏻ on the remote to turn the receiver off and then on again.
- Hold down I/⏻ on the receiver until the lamp above the button flashes in green to reboot the receiver.

Error messages

If there is a malfunction, the display shows a code of two numbers and a message. You can check the status of the system by the message. See the following table to solve the problem. If any problem persists, consult your nearest Sony dealer.

PROTECTOR

The upper panel of the receiver is covered with something. The receiver will automatically turn off after a few seconds. Remove the object covering the upper panel of the receiver and turn on the power again.

For other messages, see “Message list after auto calibration measurement” (page 50), “DIGITAL MEDIA PORT message list” (page 60) and “Message list” (page 71).

Clearing the memory

Reference sections

To clear	See
All memorized settings	page 42
Multifunction remote commander	page 154

To clear the memory of the simple remote commander

After removing the batteries, do not use the remote for a few minutes.

About support information

Refer to the following web site for details of the latest information on the receiver.
<http://www.sony.com/essupport>

Specifications

AUDIO POWER SPECIFICATIONS

POWER OUTPUT AND TOTAL HARMONIC DISTORTION:

With 8 ohm loads, both channels driven, from 20 – 20,000 Hz; rated 120 watts per channel minimum RMS power, with no more than 0.09% total harmonic distortion from 250 milliwatts to rated output.

Amplifier section

POWER OUTPUT

Rated Power Output at Stereo Mode^{1) 2)}
(8 ohms 20 Hz – 20 kHz,
THD 0.09%):
120 W + 120 W

Reference Power Output at Stereo Mode
(4 ohms 20 Hz – 20 kHz,
THD 0.15%):
85 W + 85 W

Reference Power Output
(8 ohms 1 kHz, THD 0.7%)
FRONT²⁾:
130 W + 130 W
CENTER²⁾: 130 W
SURROUND²⁾:
130 W + 130 W
SURROUND BACK²⁾:
130 W + 130 W

Reference Power Output
(4 ohms 1 kHz, THD 0.7%)
FRONT²⁾:
100 W + 100 W
CENTER²⁾: 100 W
SURROUND²⁾:
100 W + 100 W
SURROUND BACK²⁾:
100 W + 100 W

¹⁾Depending on the sound field settings and the source, there may be no sound output.

²⁾Measured under the following conditions:
Power requirements: 120 V AC, 60 Hz

Frequency response

PHONO	RIAA equalization curve ± 1.0 dB (20 Hz – 20 kHz)
MULTI CHANNEL INPUT, SA-CD/CD, MD/TAPE, TV, VIDEO 1/2, BD, DVD, SAT/CATV	10 Hz – 100 kHz ± 3 dB

Inputs (Analog)

PHONO	Sensitivity: 2.5 mV Impedance: 50 kohms S/N: 90 dB (A, 20 kHz LPF)
MULTI CHANNEL INPUT, SA-CD/CD, MD/TAPE, TV, VIDEO 1/2, BD, DVD, SAT/CATV	Sensitivity: 150 mV Impedance: 50 kohms S/N: 100 dB (A, 20 kHz LPF)

Inputs (Digital)

BD, DVD, SA-CD/CD (Coaxial)	Impedance: 75 ohms S/N: 96 dB (A, 20 kHz LPF)
VIDEO 1/2, TV, MD/TAPE (Optical)	S/N: 96 dB (A, 20 kHz LPF)

Outputs

MD/TAPE (REC OUT), VIDEO 1, ZONE 2, ZONE 3 (AUDIO OUT)	Voltage: 150 mV Impedance: 1 kohm
FRONT L/R, CENTER, SURROUND L/R, SURROUND BACK L/R, FRONT HIGH L/R, SUBWOOFER	Voltage: 2 V Impedance: 1 kohm

FM tuner section

Tuning range	87.5 – 108.0 MHz
Antenna (aerial)	FM wire antenna (aerial)
Antenna (aerial) terminals	75 ohms, unbalanced

AM tuner section

Tuning scale	10 kHz step	9 kHz step
Tuning range	530 – 1,710 kHz	531 – 1,710 kHz

Intermediate frequency

450 kHz

Antenna (aerial) Loop antenna (aerial)

Video section

Inputs/Outputs

Video: 1 Vp-p, 75 ohms

COMPONENT VIDEO:

Y: 1 Vp-p, 75 ohms

P_B: 0.7 Vp-p, 75 ohms

P_R: 0.7 Vp-p, 75 ohms

80 MHz HD Pass Through

HDMI Video

Input/Output (HDMI Repeater block)

640 × 480p@60 Hz

720 × 480p@59.94/60 Hz

1280 × 720p@59.94/60 Hz

1920 × 1080i@59.94/60 Hz

1920 × 1080p@59.94/60 Hz

720 × 576p@50 Hz

1280 × 720p@50 Hz

1920 × 1080i@50 Hz

1920 × 1080p@50 Hz

1920 × 1080p@24 Hz

HDMI Video (3D)

Input/Output (HDMI Repeater block)

1280 × 720p @ 59.94/60 Hz Frame packing

1280 × 720p @ 59.94/60 Hz Top-and-Bottom

1920 × 1080i @ 59.94/60 Hz Frame packing

1920 × 1080i @ 59.94/60 Hz

Side-by-Side (Half)

1920 × 1080p @ 59.94/60 Hz

Side-by-Side (Half)

1280 × 720p @ 50 Hz Frame packing

1280 × 720p @ 50 Hz Top-and-Bottom

1920 × 1080i @ 50 Hz Frame packing

1920 × 1080i @ 50 Hz Side-by-Side (Half)

1920 × 1080p @ 50 Hz Side-by-Side (Half)

1920 × 1080p @ 24 Hz Frame packing

1920 × 1080p @ 24 Hz Top-and-Bottom

Supported playback formats

Content delivered from the device on the home network needs to support the following formats for you to play back content on this receiver.

Type of content	Format	Other conditions
Music	Linear PCM	LPCM defined in DLNA guidelines 1.0 Sampling Rate: 44.1 kHz, 48 kHz Channels: 1, 2 Quantization: 16 bit
	MPEG-1 Layer3 (MP3)	MPEG defined in DLNA guidelines 1.0 Bitrate: 32, 40, 48, 56, 64, 80, 96, 112, 128, 160, 192, 224, 256, 320 kbps Sampling Rate: 32 kHz, 44.1 kHz, 48 kHz Channels: 1, 2 Encoding: CBR, VBR
Windows Media Audio (WMA)	WMA_FULL and WMA_BASE defined in DLNA guidelines 1.0	Maximum Bitrate: 385 kbps Sampling Rate: up to 48 kHz Channels: 2 Not compatible with WMA Pro files.
AAC	AAC_ISO defined in DLNA guidelines 1.0	AAC Profile @ Level 1, @ Level 2 Sampling Rate: 8, 11.025, 12, 16, 22.05, 24, 32, 44.1, 48 kHz Maximum Bitrate: 576 kbps Channels: 1, 2 Some files may not be played back.
WAV	Conforms to Linear PCM.	Some files may not be played back.

Type of content	Format	Other conditions
Photo	JPEG	JPEG_SM, JPEG_MED, or JPEG_LRG defined in DLNA guidelines 1.0 Maximum Resolution: 4096 × 4096 Non-progressive JPEG
	BMP	Conforms to JPEG. Some files may not be played back.
	PNG	Conforms to JPEG. Some files may not be played back.

Type of content	Format	Other conditions
Video	MPEG-2 (NTSC)	MPEG_PS_NTSC defined in DLNA guidelines 1.0 Maximum Resolution: 720 × 480 Maximum System Bitrate: 10.08 Mbps Maximum Bitrate* CBR: 9.80 Mbps/VBR: 9.80 Mbps * Bitrate is mixed with MPEG-1 Layer 1/2/3, PCM, or AC3 audio format.
	MPEG-2 (PAL)	MPEG_PS_PAL defined in DLNA guidelines 1.0 Maximum Resolution: 720 × 576 Maximum System Bitrate: 10.08 Mbps Maximum Bitrate* CBR: 9.80 Mbps/VBR: 9.80 Mbps * Bitrate is mixed with MPEG-1 Layer 1/2/3, PCM, or AC3 audio format.
	Windows Media Video (WMV)	Maximum Resolution: 720 × 480 Maximum Bitrate: 2 Mbps Windows Media Video 7/8/9 standard definition for Main profile mixed with Windows Media Video 7/8/9 excludes all profile of Windows Media Audio professional. Some files may not be played back.

Notes

- Not compatible with DRM protected files.
- Depending on the files, there may be files that sometimes cannot be played back, even if they meet the requirements described above.
- Concerning the formats defined in the DLNA guidelines, the server is required to offer the content to which the format information defined in the DLNA guidelines has been added properly.

General

Power requirements 120 V AC, 60 Hz

Power output (DIGITAL MEDIA PORT)
DC OUT: 5 V, 700 mA

Power consumption 360 W

Power consumption (during standby mode)
0.5 W (When “Control for
HDMI,” “Network
Standby;” and “RS232C
Control” are set to “OFF;”
and the power for zone 2/
zone 3 is turned off.)

Dimensions 430 × 160 × 390 mm
(16 ⁷/₈ × 6 ¹/₄ × 15 ³/₈
inches)
(width/height/depth)
including projecting parts
and controls

Mass (Approx.) 12.9 kg (28 lb 7 oz)

Supplied accessories

Operating Instructions (this manual)

Quick Setup Guide (1)

GUI Menu List (1)

Software License Information (1)

Optimizer microphone ECM-AC2 (1)

FM wire antenna (aerial) (1)

AM loop antenna (aerial) (1)

AC power cord (mains lead) (1)

Multifunction remote commander (1)

Simple remote commander (1)

R6 (size-AA) batteries (4)

IR Blaster (1)

Speaker cord connection tool (1)

Setup Manager CD-ROM (1)

VAIO Media plus CD-ROM (1)

Design and specifications are subject to
change without notice.

- Standby power consumption 0.5 W.
- Halogenated flame retardants are not used in the printed wiring boards.

Index

Symbols

⌘ SIGNAL GND terminal 37

Numerics

12V Trigger 118
 2 channel 72
 2ch Analog Direct 72
 2ch Stereo (mode) 72
 4 ohms 44
 5.1 channel 20
 7.1 channel 20
 8 ohms 44

A

A.F.D. (mode) 73
 A.F.D. Multi Stereo 73
 A.P.M. (Automatic Phase Matching) 110
 A/V Sync 119, 134
 AC power cord 42
 Account 84
 AM 62
 Antenna Aiming 66
 Audio 119
 AUDIO OUT 135
 Audio Out 123
 Audio Return Channel (ARC) 101
 Auto Calibration 46, 110, 130
 Auto Standby 127
 Auto Tuning 62

B

Bass 8, 117, 133
 BI-AMP 112
 Bi-amplifier connection 107
 Blu-ray Disc Player 26, 28, 57

C

Calibration Start 48
 Calibration Type Select 49, 130
 Category Mode 66
 CD player 34, 37
 Changing the display 135

Clear

memory 42
 remote 154

Connections

antennas 39
 audio components 34
 monitor 24
 Network 40
 speakers 22
 video components 25

Control for HDMI 123

Controller 83

Controllers 125

Crossover Freq 113, 133

D

D. Range Comp (Dynamic range compressor)
 115, 131
 DCAC (Digital Cinema Auto Calibration) 46
 Decode Priority 119, 134
 Device Name 126
 Digital Legato Linear (D.L.L.) 119
 DIGITAL MEDIA PORT 14, 34, 58
 Direct Tuning 62, 67
 Display 10
 Distance Unit 115, 132
 DLNA 79
 DMPort Control 61
 Dolby Digital EX 78
 Dual Mono 119, 134
 DVD player 26, 28
 DVD recorder 31

E

Effect type 116, 133
 EQ 117
 External Control 125

F

Favorite stations 88
 FM 62
 FM Mode 62, 134

G

GUI (Graphical User Interface) 24

H

HD-D.C.S. 76

HD-D.C.S. (Effect Type) 116

HDMI 123

HDMI jacks 25

I

Input 57

Input Assign 102

INPUT MODE 101

iPod 61

L

L.F.E. (Low Frequency Effect) 11

Large 113

Level 117

Listening 87

Lock Code 69, 134

M

Manual Setup 112

MASTER VOLUME 9

Menu 54, 109

Messages

 Auto Calibration 50

 DIGITAL MEDIA PORT 60

 Error 162

 SIRIUS 71

Movie 76

Multi Zone 90, 117

Music 59, 74

Music Guide 85

Muting 57

My Library 80

My Library (Rhapsody) 86

N

Name Input 58, 64, 111

Neo:6 (Cinema) 76

Neo:6 (Music) 74

Network settings

 Check 124

Network Standby 126

Night Mode 104, 120, 134

O

Option menu 55

P

Parental Lock 68, 134

Pass Through 100, 123

Phase Audio 114, 131

Phase Noise 114, 131

PHONES 9

PLII (Movie) 76

PLII (Music) 74

PLIIx (Movie) 76

PLIIx (Music) 74

PLIIz Height 74, 76

Position (Auto Calibration) 111, 130

Preset channels 68

Preset Mode 68

Preset stations 64

PROTECTOR 162

Q

Quick Click 136

R

Radio ID 66

Recording 105

Remote 15–18, 43, 146–154

Repeat 60, 81

Resetting 42

Resolution 121, 135

Rhapsody

 Account 84

 Music Guide 85

 My Library 86

 Rhapsody Digital Music Service 84

 Rhapsody Stations 85

 Search 85

Rhapsody Digital Music Service 84

Rhapsody Stations 85

RS232C Control 127

S

Satellite radio 65

Search 85

Server
 Preparing 52
Setting menu 109
Settings 109
Settings Lock 127
Setup Manager 88
SHOUTcast
 Favorite stations 88
 Listening 87
Shuffle 60, 81
SIRIUS 65
SIRIUS Satellite Radio 65
Sleep timer 104
Small 113
Software Version 128
Speaker 112
Speaker impedance 43
Speaker Pattern 112, 132
SPEAKERS (A/B/A+B/OFF) 9, 45
Subwoofer Level 123, 135
Subwoofer LPF 123
Super Audio CD player 34, 36, 37
Sur Back Assign 112
Sur Settings 133
Surround 116
System 127

T

Test Tone 114, 131
TONE 8
TONE MODE 8, 42
Treble 8, 117, 133
Tuner 62
Tuning 62, 64

U

Up converting 32

V

VCR 31
Video 59, 121
VIDEO 2 IN jacks 32

Z

Zone 12V Trigger 133
ZONE 2 112
Zone2 Line Out Level 118

